

L-Series AM-3RU Sliding Patch Panel



Description

The L-Series 3RU sliding patch panel has a smoked acrylic glass hinged front door and has been designed to accept up to 9 L-Series Adapter Plates or MPO Cassettes for a maximum of 216f using an LC presentation. With a range of adapter types, this panel offers flexibility to the end-user, allowing easy access during installation or reconfiguration with no disturbance of the existing cable or fibers. The panel also offers multiple cable entry solutions:

- MPO trunk cables connected to 9 individual MPO cassettes with up to 24 fibers in each
- Loose tube cable to be spliced into standard splice cassettes to allow standard splicing
- Pre-terminated solutions

The versatility of the L-Series AM-3RU Sliding Patch Panel makes it one of the most flexible solutions on the market. The AFL Hyperscale L-Series is compatible with the industry-standard LGX format.

Features and Benefits

- Up to 9 L-Series Cassettes in 3RU for a maximum of 216f using an LC presentation
- Multiple adapter options available
- Sliding tray for ease of installation
- Side patch cord exit
- 19" and 23" rack-mountable
- Accepts loose tube, distribution, and MPO trunk cable
- Integrated spring-loaded tray stop
- Hinged front acrylic glass door and a removable top cover

- Materials are RoHS, REACH, and SVHC compliant

Applications

- Data centers, premise installations, telecommunication networks
- Indoor applications
- Ethernet, Fiber Channel, ATM, LAN, MAN, and WAN

Specifications

3RU MODULAR PATCH PANEL CHASSIS	
Height	3RU (133.4mm)
Width	432mm
Depth	356mm
Net weight	8.0kg
Packaged weight	8.5kg
Packaged dimensions	510mm (W) x 450mm (L) x 210mm (H)
Suitable for adapter type	L-Series Adapter Plates / MPO Cassettes
Number of cassette positions	9
IP rating	IP20
Material	Cold-rolled steel
Material thickness	1.2mm
Material finish	Powder coating
Color	Black
Operating temperature	-40°C to +60°C
Designed in accordance with	TIA/EIA 568.C, ISO/IEC 11801, EN50173, IEC60304, IEC61754,
Materials compliant to	RoHS, Reach, SVHC

Technical Drawing

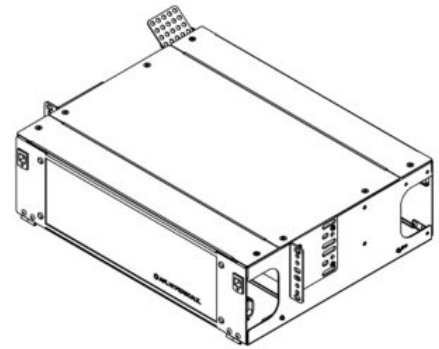
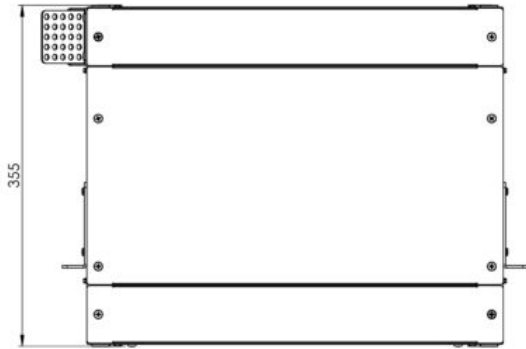

Isometric View

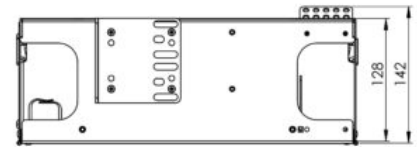
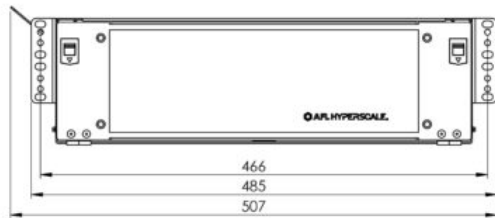

Ordering Information

PART NUMBER	DESCRIPTION	LEGACY PART NUMBER
FXLCXXBXXX-03AB	AFL Hyperscale L-Series LGX Sliding Panel AM Style 3RU for 9 LGX Cassettes Splice Trays Black	AM3U

Regional Availability

USA

+1-866-814-8615
usasales@afllhyperscale.com

EMEA

+44 1908 441 144
emeasales@afllhyperscale.com

INDIA

+91 80 46874687
indiasales@afllhyperscale.com

APAC

(excluding India)
+86 755 2561 3694
apacsales@afllhyperscale.com

Additional Images

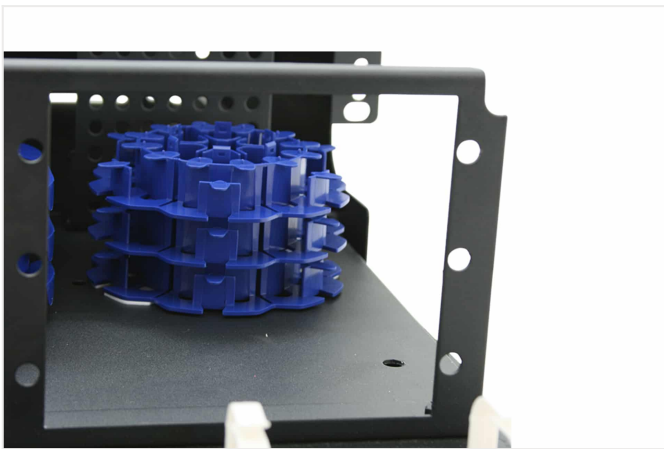

Related Products

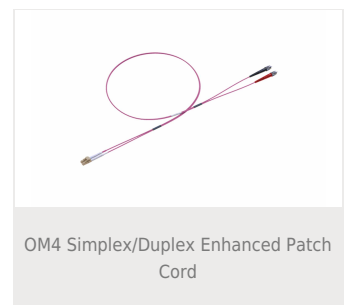
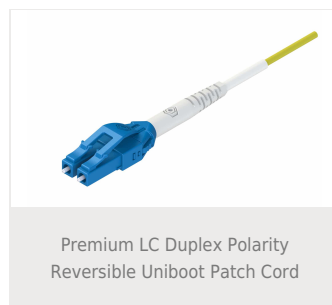
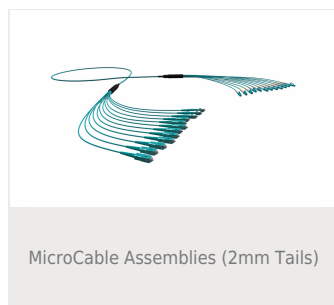

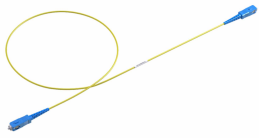

SM Simplex/Duplex Enhanced Patch Cord



Premium Pigtailed



FCP2 Fiber Cleaning Kit for SC/ST/FC/LC



FOCIS Flex Fiber Scope