

The power behind competitiveness

Delta UPS - Amplon Family

RT Series, Three Phase
10/ 15/ 20 kVA

User Manual

www.deltapowersolutions.com



DELTA
Smarter. Greener. Together.

SAVE THIS MANUAL

This manual contains important instructions and warnings that you should follow during the installation, operation, storage and maintenance of this product. Failure to heed these instructions and warnings will void the warranty.

Copyright © 2021 by Delta Electronics Inc. All Rights Reserved. All rights of this User Manual ("Manual"), including but not limited to the contents, information, and figures are solely owned and reserved by Delta Electronics Inc. ("Delta"). The Manual can only be applied to the operation or the use of this product. Any disposition, duplication, dissemination, reproduction, modification, translation, extraction, or usage of this Manual in whole or in part is prohibited without the prior written permission of Delta. Given that Delta will continuously improve and develop the product, changes may be made to the information in this Manual at any time without obligation to notify any person of such revision or changes. Delta will make all possible efforts to secure the accuracy and the integrity of this Manual. Delta disclaims any kinds or forms of warranty, guarantee, or undertaking, either expressly or implicitly, including but not limited to the completeness, faultlessness, accuracy, non-infringement, merchantability or fitness for a particular purpose of the Manual.

Table of Contents

Chapter 1: Important Safety Instructions	p. 3
Chapter 2: Introduction	p. 7
Chapter 3: Operation Panel.....	p. 12
Chapter 4: Rear Panel.....	p. 21
Chapter 5: Communication Interfaces	p. 24
Chapter 6: Installation.....	p. 27
Chapter 7: UPS Connection	p. 37
Chapter 8: External Battery Pack	p. 69
Chapter 9: Operation	p. 87
Chapter 10: LCD Display & Settings	p. 93
Chapter 11: Optional Accessories.....	p. 111
Chapter 12: Troubleshooting	p. 113
Chapter 13: Maintenance	p. 119
Appendix 1: Technical Specifications.....	p. 121
Appendix 2: Warranty	p. 123

Chapter 1 : Important Safety Instructions

1.1 Safety Instructions

Installation Warnings





- Before installation and usage, please read this ***User Manual*** thoroughly. This helps you to use the product correctly and safely.
- Install the UPS in a well-ventilated indoor area, away from excess moisture, heat, dust, flammable gas or explosives. To avoid fire accidents and electric shock, the indoor area must be free of conductive contaminants. For the temperature and humidity specifications, please refer to ***Appendix 1: Technical Specifications***.
- Follow the IEC 60364-4-42 standard to install the UPS.
- Leave adequate space (at least 50 cm (19.7")) at the front and rear of the UPS for proper ventilation.

Connection Warnings

- The UPS must be well grounded due to a possible risk of current leakage.
- It is necessary to connect protective devices with the UPS when the UPS is connected to power sources and critical loads.
- The protection devices connected to the UPS must be installed near the UPS and must be easily accessible for operation.
- If you need to move the UPS or perform re-wiring, please turn off the AC input power and disconnect the battery input to ensure that the UPS has been safely shut down. Otherwise, the output end might still be energized, which might cause electric shock.

Usage Warnings

- This is a class-A product. In a domestic environment, this product may cause radio interference, in which case the user is required to take adequate measures.
- The UPS can be used to power computers and associated peripheral devices, such as monitors, modems, cartridge tape drives, external hard drives, etc.
- It is not recommended to connect the UPS with the following types of loads. For the load suitability, please contact Delta customer service before purchasing.
 1. regenerative loads (e.g. CNC machines and lifts)
 2. asymmetrical loads (e.g. fans with half-bridge drivers and laser printers)

- To ensure reliable operation of the UPS and to protect the UPS from overheating, the slits and openings in the UPS must not be blocked or covered.
- Before usage, you must allow the UPS to adjust to room temperature for at least one hour to ensure that there is no moisture condensing inside the UPS.
- Do not pour and splash any liquid on the UPS. Do not insert any object into the UPS's slits and openings. Do not put beverages on or around the UPS.
- When an emergency occurs, (1) press and hold the ON/ OFF button () for 3 seconds, (2) release it after you hear the beep sound, (3) use the Scrolling Up or Down button ( / ) to select 'Yes', and (4) press the Enter button () to confirm your selection to turn off the UPS. After that, cut off the input power to shut down the UPS completely.
- Do not use any cleaning liquid or cleaning spray to clean the UPS. Before cleaning, please make sure that the UPS has been shut down completely, the UPS's input power cables have been unplugged, and the batteries have been disconnected.
- All maintenance services must be performed by qualified service personnel.
- Forbid opening or removing the cover of the UPS by yourself to avoid high voltage electric shock.
- You must contact qualified service personnel if either of the following events occurs:
 1. Liquid is poured or splashed on the UPS.
 2. The UPS does not run normally after the instructions in this **User Manual** are carefully observed.





NOTE:

If you use the UPS in an area that generates or incurs dust, you should install a dust filter (optional) in the UPS to ensure its normal product life and functions.

Battery Precautions

- Keep the batteries away from heat sources. Do not open or mutilate the batteries.
- Do not dispose of batteries in a fire. The batteries may explode.
- The released electrolyte is harmful to skin and eyes and may be toxic.
- A battery can present a risk of electric shock and high short-circuit current.

- Servicing of the batteries and battery packs must be performed or supervised by qualified service personnel knowledgeable in the batteries, battery packs and required precautions. Keep unauthorized personnel away from the batteries and battery packs.
- The risk of electric shock and short-circuit current is possible when the batteries are connected to the UPS. Before maintenance, disconnect all batteries to cut off the battery power.
- For battery replacement, use only the same number and type of batteries.
- Observe the following before replacing the batteries:
 1. Remove watches, rings, or other metal objects.
 2. Use tools with insulated handles.
 3. Wear rubber gloves and boots.
 4. Do not lay tools or metal parts on the top of batteries.
 5. Disconnect the charging source prior to connecting or disconnecting the battery input terminals.
 6. Remove every battery grounding during installation and maintenance to reduce the likelihood of electric shock. If any part of the batteries is grounded, please remove the grounding connection.
- Do not connect the batteries in reverse; otherwise, an electric shock or fire accident might occur.
- The batteries might lose their power during shipment or storage. Before you use the UPS for the first time, please fully charge the batteries until the battery percentage shown on the UPS's LCD is 100% (). If the UPS needs to be stored for an extended period of time, please fully recharge the lead-acid batteries (for at least 24 hours) every three months. As for lithium-ion batteries and other batteries, please contact your battery vendor for the information. Regardless of battery type, please fully charge the batteries until the battery percentage shown on the LCD is 100% ().



NOTE:

To charge the batteries, please connect the external battery pack to the UPS.



WARNING:

1. The risk of electric shock and short-circuit current is possible when the batteries are still connected to the UPS even if the UPS has been disconnected from the mains. Make sure to cut off the battery source before maintenance.
2. When the UPS is connected to an external battery pack, installation of appropriate protection devices, such as DC fuses or a DC breaker, is required.

1.2 Standard Compliance





- CE, UL/ cUL, RCM, TISI, Energy star
- UL1778 (for UPS + EBC), IEC/ EN 62040-1 (for UPS + EBC + PDB/ MBB)
- EN 62040-2 Category C2/ FCC class A

1.3 Storage

● **Prior to installation**

If the UPS needs to be stored prior to installation, it should be placed in a dry and well-ventilated area. The allowable storage temperature is between -15°C (5°F) and +55°C (131°F) and the allowable relative humidity (non-condensing) is between 5% and 95%.

● **After usage**

(1) Press and hold the ON/ OFF button () for 3 seconds, (2) release it after you hear the beep sound, (3) use the Scrolling Up or Down button (/) to select 'Yes', and (4) press the Enter button () to confirm your selection to turn off the UPS. Make sure the UPS is shut down, disconnect the UPS from the utility AC power, remove all loads/ equipment from the UPS, and store the UPS in a dry and well-ventilated area at a temperature between -15°C (5°F) and +55°C (131°F) and at a relative humidity (non-condensing) between 5% and 95%.

If the UPS needs to be stored for an extended period of time, please recharge the idle batteries regularly. Refer to the above section **Battery Precaution** for relevant information.



NOTE:

1. To charge the batteries, please connect the external battery pack to the UPS.
2. After storage and before start-up of the UPS, you must allow the UPS to adjust to room temperature (20°C ~ 25°C (68°F ~ 77°F)) for at least one hour to ensure that there is no moisture condensing inside the UPS.

Chapter 2 : Introduction

2.1 Product Description

The RT series UPS (models available: RT-10K3P, RT-15K3P and RT-20K3P) is an advanced on-line and double-conversion UPS which provides your sensitive equipment with reliable and consistent sine-wave power. It helps to save on electricity costs and keep your electronic equipment safe and able to run smoothly at all times. The unit's output power factor is up to unity, achieving power and energy efficiency.

The UPSs accept three-phase power supply. When taking three-phase input power, the UPS output can be configured into three-phase or single-phase to adapt to your loads. You can connect a variety of facilities such as personal computers, networks, servers, and telecommunication equipment to the UPS.

The UPS does not have internal batteries and must be connected to an external battery pack. See the battery options below.

1. Standard battery pack (optional) – Delta lead-acid battery pack or Delta lithium-ion battery pack (RT-20K-LIB/ RT-10K-LIB)
2. Customer-owned battery pack – lead-acid battery or others

2.2 Exterior & Dimensions

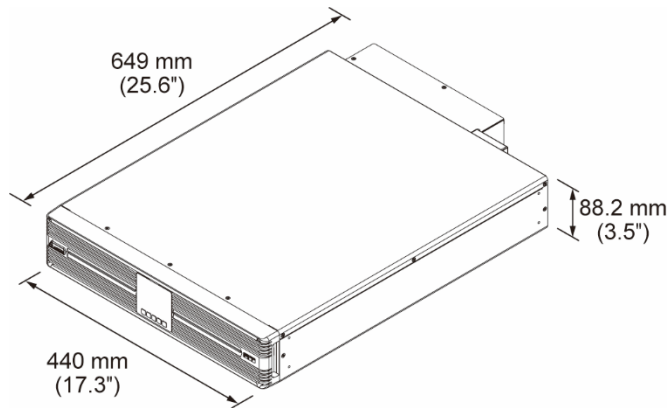

(Figure 2-1-1: RT-10K3P UPS_ Exterior & Dimensions)

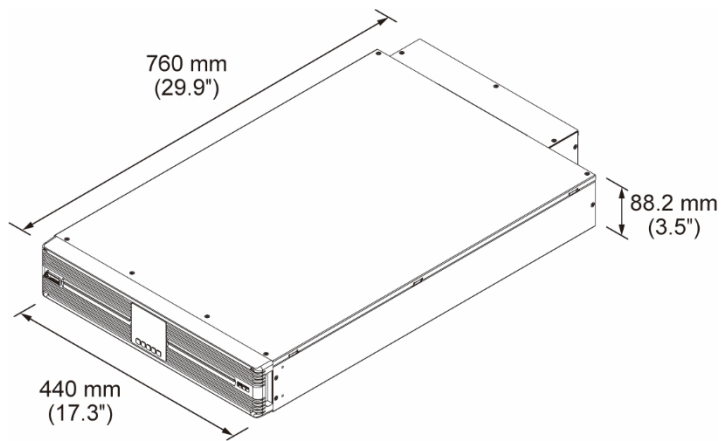

(Figure 2-1-2: RT-15K3P/ RT-20K3P UPS_ Exterior & Dimensions)

2.3 Package List

The package contains the following items. Please check if any item is missing. If there is anything missing, please contact the dealer immediately.

Models: UPS103R6RT2N035/ UPS103R6RT2N0B0

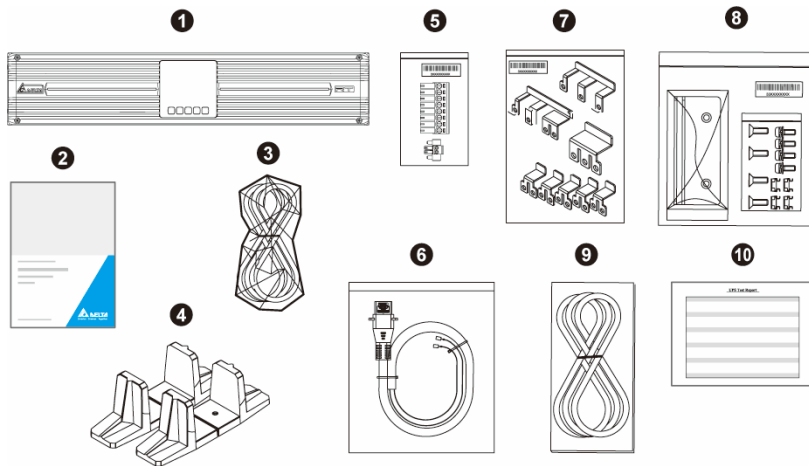

No.	Item	Q'ty
1	UPS	1 PC
2	User Manual	1 PC
3	Parallel Cable	1 PC
4	Tower Stand	1 Set
5	Terminal Kit	1 Set
6	Battery Cable (1500 mm (59''))*1	1 PC
7	Bus Bar	1 Set
8	Ear Bracket Kit	1 Set
9	USB Cable	1 PC
10	Factory Test Report	1 PC

Models: UPS153R6RT2N035/ UPS203R6RT2N035/ UPS153R6RT2N0B0/ UPS203R6RT2N0B0

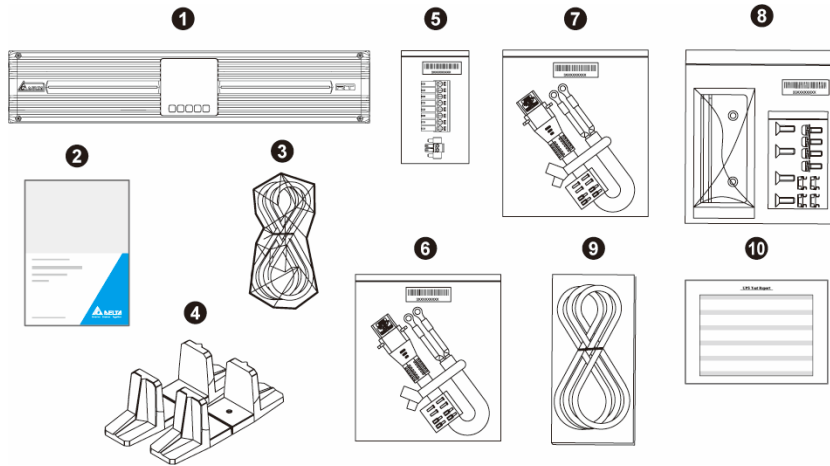

No.	Item	Q'ty
1	UPS	1 PC
2	User Manual	1 PC
3	Parallel Cable	1 PC
4	Tower Stand	1 Set
5	Terminal Kit	1 Set
6	Battery Cable*2 (330mm (13"), used for connection to the optional Delta lead-acid battery pack)	1 PC
7	Battery Cable*2 (500mm (19.7"), used for connection to the optional Delta lead-acid battery pack)	1 PC
8	Ear Bracket Kit	1 Set
9	USB Cable	1 PC
10	Factory Test Report	1 PC



NOTE:

1. *1 The battery cable is for connection to the customer-owned lead-acid battery pack.
2. *2 The two battery cables are for connection to the 15/20K UPS shipped without battery cables already being installed; the connection should be performed by qualified service personnel. For details, please refer to **Chapter 8.5.1**.
3. If there is any damage or anything missing, please immediately contact the dealer from whom you purchased the unit.
4. If the UPS needs to be returned, carefully repack the UPS and all of the accessories using the original packing materials.

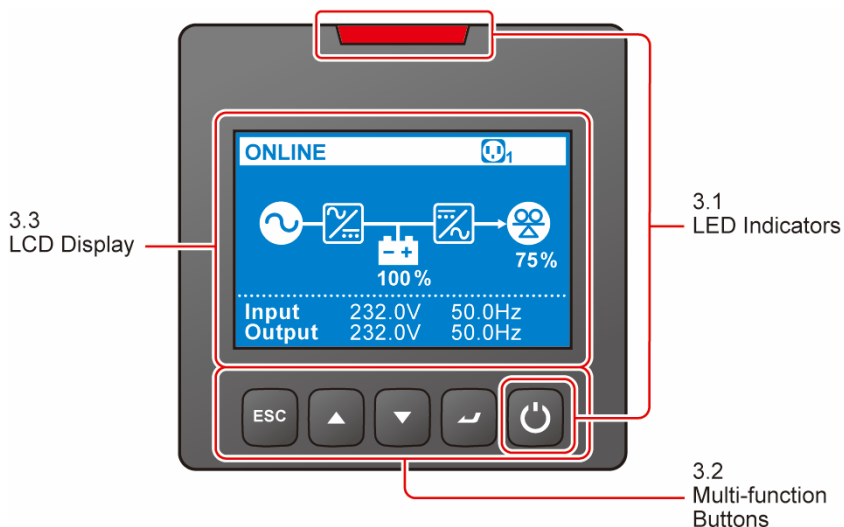

Chapter 3 : Operation Panel

The operation panel is located on the front of the UPS with two LED indicators, an LCD display, and multi-function buttons. See **Figure 3-1**.







(Figure 3-1: Operation Panel)





3.1 LED Indicators





No.	LED Indicator	Description
1		ON: The output is protected. OFF: The output is not protected.
2		ON: The UPS detects an internal fault or environmental abnormality. OFF: The UPS is in a normal state. Flashing: The UPS sends an alarm message. For details about the alarm messages, please refer to Chapter 12 .

3.2 Multi-function Buttons

No.	Multi-function Button	Description
1	 <p data-bbox="262 923 371 1000">ON/ OFF Button</p>	<p data-bbox="430 401 1204 473">The button has multiple functions. Please refer to the following for detailed information.</p> <p data-bbox="430 542 559 569">1. Turn on</p> <ul data-bbox="430 591 1245 904" style="list-style-type: none"> <li data-bbox="430 591 1204 710">➤ In standby/ bypass mode, press and hold the button for 3 seconds, and release it after you hear the beep sound. After that, the UPS will start up. <li data-bbox="430 736 1245 904">➤ Cold start: when there is no AC input, press and hold the button for 3 seconds, and release it after you hear the beep sound. After that, the UPS will run in battery mode. Please refer to Chapter 9.1.2 for details. <p data-bbox="430 973 565 1000">2. Turn off</p> <ul data-bbox="430 1022 1245 1425" style="list-style-type: none"> <li data-bbox="430 1022 1245 1284">➤ In online mode, press and hold the button for 3 seconds, and release it after you hear the beep sound. After that, the inverter will be off and the UPS will transfer to run in standby/ bypass mode. The UPS will keep charging the batteries when in standby/ bypass mode. To fully turn off the UPS, please disconnect the UPS from the AC power. <li data-bbox="430 1309 1245 1425">➤ In battery mode, press and hold the button for 3 seconds, and release it after you hear the beep sound. After that, the UPS will turn off its output.

No.	Multi-function Button	Description
	 <p>ON/ OFF Button (Continued)</p>	<p>3. Fault clear</p> <p>When the UPS is under a fault condition, press and hold the button for 3 seconds, and release it after you hear the beep sound. After that, the UPS will try to clear the fault and restart itself.</p> <p>After the UPS's restart, if the fault condition has been cleared successfully, the buzzer will be off and the alarm message on the screen (refer to Chapter 3.3.1) will disappear. Otherwise, the buzzer will still be on and the alarm message will remain on the screen. To clear the fault, please refer to Chapter 12.</p>
2	 <p>Enter Button</p>	<p>The button has multiple functions. Please refer to the following for detailed information.</p> <p>1. Enter the Main Menu</p> <p>In the Main Screen (that shows the current operation mode), press the button for 0.1 second and the UPS will enter the Main Menu. Please refer to Chapter 10 for details.</p> <p>2. Select and confirm the parameter</p> <p>Press the button to choose the parameter that you want to change, and the chosen parameter will flash. Then, press the Scrolling Up or Down button (/) to change the parameter, and press the enter button again to confirm the change.</p>

No.	Multi-function Button	Description
3	 <p data-bbox="237 813 395 890">Scrolling Up Button</p>	<p data-bbox="430 314 1204 388">The button has multiple functions. Please refer to the following for detailed information.</p> <p data-bbox="430 459 659 488">1. Shortcut button</p> <p data-bbox="430 504 1245 629">In the Main Screen, press the button for 0.1 second and the UPS will directly enter the Measurement Menu's Output screen. For details about the LCD items, see <i>Figure 10-1: Menu Tree</i>.</p> <p data-bbox="430 697 913 726">2. Scroll up/ increase the setting value</p> <ul data-bbox="430 741 1243 1103" style="list-style-type: none"> <li data-bbox="430 741 1243 815">➤ The button can be used to navigate the setting items. Press the button for 0.1 second to go to the previous setting item. <li data-bbox="430 836 1243 1103">➤ The button can also be used to set up the parameter. Press the button for 0.1 second to increase the setting value. If the button is pressed for more than 2 seconds, the setting value will increase by its minimum adjustable unit every 0.2 second automatically until the button is released or the setting value reaches the maximum. <p data-bbox="430 1170 642 1199">3. Reset the LCD</p> <p data-bbox="430 1215 1232 1296">Press the Scrolling Up button () and Scrolling Down button () together for 3 seconds to reset the LCD display.</p>
4	 <p data-bbox="233 1514 399 1591">Scrolling Down Button</p>	<p data-bbox="430 1348 1204 1421">The button has multiple functions. Please refer to the following for detailed information.</p> <p data-bbox="430 1489 659 1518">1. Shortcut button</p> <p data-bbox="430 1534 1245 1659">In the Main Screen, press the button for 0.1 second and the UPS will directly enter the Measurement Menu's Output screen. For details about the LCD items, see <i>Figure 10-1</i>.</p>

No.	Multi-function Button	Description
	 <p>Scrolling Down Button (Continued)</p>	<p>2. Scroll down/ decrease the setting value</p> <ul style="list-style-type: none"> ➤ The button can be used to navigate the setting items. Press the button for 0.1 second to go to the next setting item. ➤ The button can also be used to set up the parameter. Press the button for 0.1 second to decrease the setting value. If the button is pressed for more than 2 seconds, the setting value will decrease by its minimum adjustable unit every 0.2 second automatically until the button is released or the setting value reaches the minimum. <p>3. Reset the LCD</p> <p>Press the Scrolling Up button () and Scrolling Down button () together for 3 seconds to reset the LCD display.</p>
5	 <p>Escape Button</p>	<p>The button has multiple functions. Please refer to the following for detailed information.</p> <p>1. Go back to the previous menu level</p> <p>Press the button for 0.1 second to go back to the previous menu level.</p> <p>2. Silence the buzzer temporarily</p> <p>When the UPS is under a fault condition, press and hold the button for 3 seconds and release it after you hear the beep sound. After that, the buzzer will stop sounding unless a new fault condition occurs. For details, please refer to Chapter 9.3.</p>



NOTE:



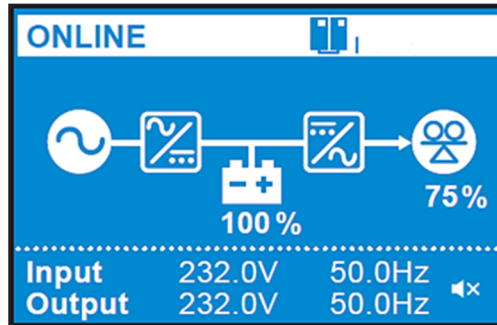

When the LCD backlight is off and you would like to wake it up, press any of the multi-function buttons listed above.

3.3 LCD Display



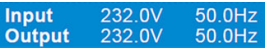

3.3.1 Icon/ Display Definition



No.	Icon	Description
1		Indicates that the UPS is operating in parallel; the number on the lower right side is the UPS's parallel ID.
2		Indicates the battery percentage (%).
		When there is no external battery pack connected to the UPS, this icon will flash.
		Indicates that the batteries are bad and need a replacement.
3		Indicates the load percentage (%).

No.	Icon	Description
4		<p>When the UPS runs normally, the input/ output voltage and frequency will show at the bottom of the screen.</p>
		<p>When the UPS has abnormalities or is under fault conditions, this display will show one of the event codes and its corresponding alarm message. For details of event codes and alarm messages, please refer to Chapter 12.</p> <p> NOTE:</p> <ol style="list-style-type: none"> 1. The event code and the alarm message will appear alternately every 5 seconds. 2. To view all the alarm history records (up to 200 pieces of data can be saved), please go to  → Log → Event List.
5		<p>Indicates that the buzzer is muted.</p>

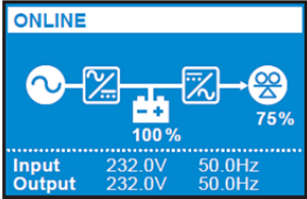
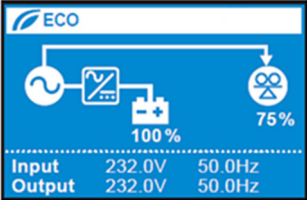
3.3.2 Operation Mode Diagram Definition

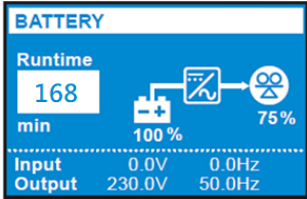
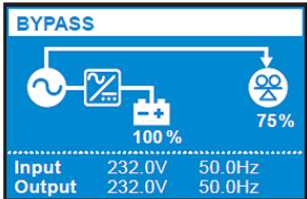
The operation mode diagrams are listed below. For more information, refer to **Chapter 9.4**.

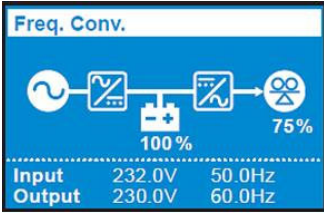
No.	Operation Mode Diagram	Description
1	 <p>The diagram shows the ONLINE mode. It features a power flow diagram with an AC input source, a rectifier, a battery, an inverter, and an AC output source. The input is labeled 'Input 232.0V 50.0Hz' and the output is 'Output 232.0V 50.0Hz'. The battery level is indicated as 100% and the load as 75%. The word 'ONLINE' is displayed in the top left corner.</p>	Indicates online mode.
2	 <p>The diagram shows the ECO mode. It features a power flow diagram with an AC input source, a rectifier, a battery, and an AC output source. The input is labeled 'Input 232.0V 50.0Hz' and the output is 'Output 232.0V 50.0Hz'. The battery level is indicated as 100% and the load as 75%. The word 'ECO' is displayed in the top left corner.</p>	<p>Indicates ECO mode.</p> <p> NOTE: In ECO mode, the power flow diagram will change according to the UPS's input voltage and frequency. However, the icon () shown in the upper-left corner will not change even if the UPS transfers to online mode or battery mode.</p>
3	 <p>The diagram shows the BATTERY mode. It features a power flow diagram with a battery, an inverter, and an AC output source. The input is labeled 'Input 0.0V 0.0Hz' and the output is 'Output 230.0V 50.0Hz'. The battery level is indicated as 100% and the load as 75%. The word 'BATTERY' is displayed in the top left corner. A 'Runtime 168 min' indicator is also present.</p>	Indicates battery mode.
4	 <p>The diagram shows the BYPASS mode. It features a power flow diagram with an AC input source, a transformer, and an AC output source. The input is labeled 'Input 232.0V 50.0Hz' and the output is 'Output 232.0V 50.0Hz'. The battery level is indicated as 100% and the load as 75%. The word 'BYPASS' is displayed in the top left corner.</p>	Indicates bypass mode.

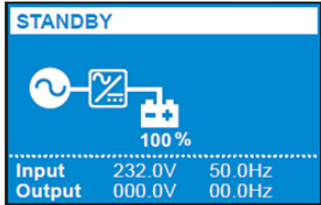
No.	Operation Mode Diagram	Description
5		<p>Indicates frequency conversion mode.</p> <p> NOTE: In frequency conversion mode, the power flow diagram will change according to the UPS's input voltage and frequency. However, the icon (Freq. Conv.) shown in the upper-left corner will not change even if the UPS transfers to battery mode.</p>
6		<p>Indicates standby mode.</p>

Chapter 4: Rear Panel

Models: UPS103R6RT2N035/ UPS103R6RT2N0B0

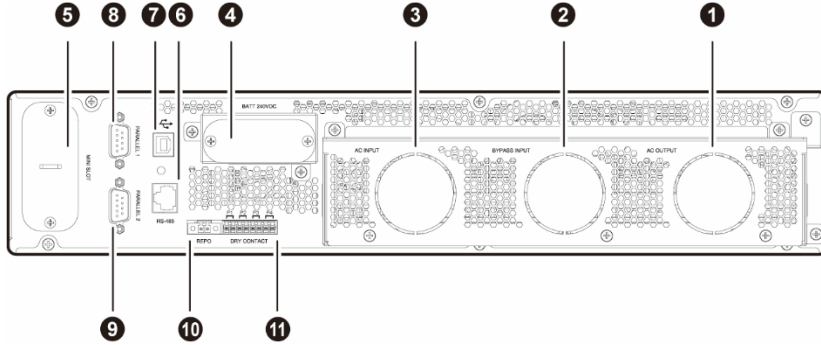

(Figure 4-1-1: RT-10K3P UPS_ Rear Panel)

Models: UPS153R6RT2N035/ UPS203R6RT2N035/ UPS153R6RT2N0B0/ UPS203R6RT2N0B0

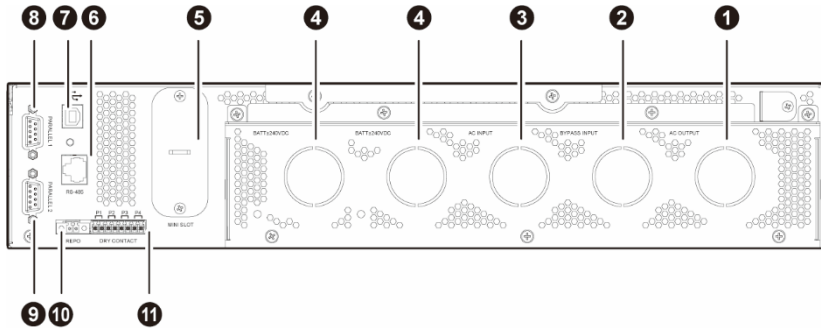

(Figure 4-1-2: RT-15K3P/ RT-20K3P UPS_ Rear Panel)

No	Item	Function
1	AC Output Terminals*1	Connected to the loads.
2	Bypass Input Terminals*1	Connected to the bypass AC source.
3	AC Input Terminals*1	Connected to the main AC source.

No	Item	Function
4	(RT-15K3P & RT- 20K3P) Battery Input Terminals*1 (RT-10K3P) External Battery Connector*2	Connected to the external battery pack(s).
5	Mini Slot	For installation of an optional mini card, such as Mini SNMP IPv6 card, Mini Relay I/O card, or Mini MODBUS card. Refer to Chapter 5 for details.
6	RS-485 Port	For connection to the lithium-ion battery pack only. Users can monitor the battery status and update its firmware via this port.
7	 USB Port	Connects to a computer to monitor the UPS status, configure the parameters and update the management firmware. Refer to Chapter 5 for details.
8	Parallel Ports	For parallel signal connection, use the parallel cable provided in each UPS's package to connect the parallel ports. Refer to Chapter 5 for details. Regarding parallel wiring, refer to Chapter 7.4 .
9		
10	REPO Port	Shuts down the UPS safely and immediately when an emergency occurs. Refer to Chapter 5 for details.
11	Dry Contacts	<ol style="list-style-type: none"> 1. One input dry contact: enables the UPS to receive external control signals. 2. Three output dry contacts: enable users to receive the UPS event information, status or internal messages for monitoring. <p>For details about the input and output dry contacts, refer to Chapter 5.</p>



NOTE:

1. *¹ Remove the upper cover at the rear of the UPS to see the wiring terminals. For the terminal cover location, see **Figure 7-2**. For the UPS's wiring terminals, see **Figure 7-3**. To perform the UPS wiring, please refer to **Chapter 7**. For battery connection, please refer to **Chapter 8**.
2. *² For RT-10K3P UPS, remove the protection cover of the battery connector before connection.

Chapter 5 : Communication Interfaces



NOTE:

1. The UPS can still function properly without making the connections below.
2. For the location of the communication interfaces, please refer to **Figure 4-1-1 and Figure 4-1-2**.
3. The maximum length allowed for the signal/ communication cables is 30 m (9.84 ft).

5.1 Mini Slot

The Mini slot is for installation of an optional mini card. You can install the optional Mini SNMP IPv6 card for network communication, Mini Relay I/O card for dry contact expansion, or Mini MODBUS card for MODBUS communication.

5.2 RS-485 Port

The port is for communication with lithium-ion batteries (baud rate: 57600); you can check and monitor the status of lithium-ion batteries and update the firmware.

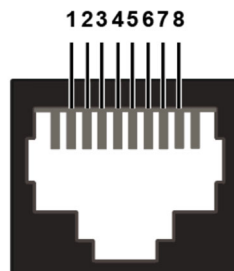

(Figure 5-1: Pin Location of RS-485 Port)

● RS-485 Pins

PIN 3: Negative CHG OFF

When your external battery setup is '**Standard Battery Pack**' – '**Li-ion Battery**', PIN 6 and PIN 3 can detect the battery connection.

When your external battery setup is '**Customer Own Batt. Pack**' – '**Others**', PIN 6 and PIN 3 can receive the CHG OFF signal from the external battery pack and disable charging; effective when PIN6 and PIN2 or PIN3 and PIN2 are shorted.

PIN 4: Battery Fault

When your external battery setup is '**Customer Own Batt. Pack**' – '**Others**', PIN 4 can receive a battery error signal; effective when PIN4 and PIN2 are shorted.

PIN 6: Positive CHG OFF



WARNING:

If you use lithium-ion batteries other than the Delta's and would like to activate the battery monitoring function, please contact your local dealer or customer service.

5.3 USB Port

Please use the provided USB cable to connect the UPS with a computer and install the UPSentry 2012 software*¹ to check and monitor the UPS status. The USB port has the following functions:

1. HID USB communication
2. UPS configurations with EEPROM programming
3. UPS firmware upgrade
4. Event logs download
5. Dry contacts setup



NOTE:

*¹ You can download the software from the following link.

<https://datacenter-softwarecenter.deltaww.com.cn>

5.4 Parallel Ports

The UPS has two parallel ports. Please use the provided parallel cable in each UPS's package to connect the parallel UPSs. You can set up relevant items in the **Setting Menu's** Parallel screen. For more information, please refer to **Chapter 10.2.2**.

The parallel ports are also for the UPS's signal connection with the optional MBB or PDB. For details, please refer to **Chapter 7.5** and **Chapter 7.6**.

5.5 REPO Port

The REPO port can be connected to an external switch. After the external switch is turned to the 'ON' or 'OFF' position (depending on the setting, please refer to **Chapter 10.2.2**), the UPS will switch off the inverter immediately and cut off the UPS output without transferring to bypass mode.

**NOTE:**

The REPO port can also be modified for ROO application, which allows you to remotely turn on/ off the inverter. If you need more ROO information or ROO setup service, please contact your local dealer or customer service. Please note that this port can only be modified by qualified service personnel.

5.6 Dry Contacts

There is one configurable input dry contact for the UPS to receive external control signals and three configurable output dry contacts for users to receive the UPS's event information, status or internal messages. Users can set up relevant items in the **Setting Menu's** Dry Contact Setting screen. For more information, please refer to **Chapter 10.2.2** and **Chapter 10.2.4**.

Chapter 6 : Installation

Please refer to the system block diagram and related information below for the correct installation.

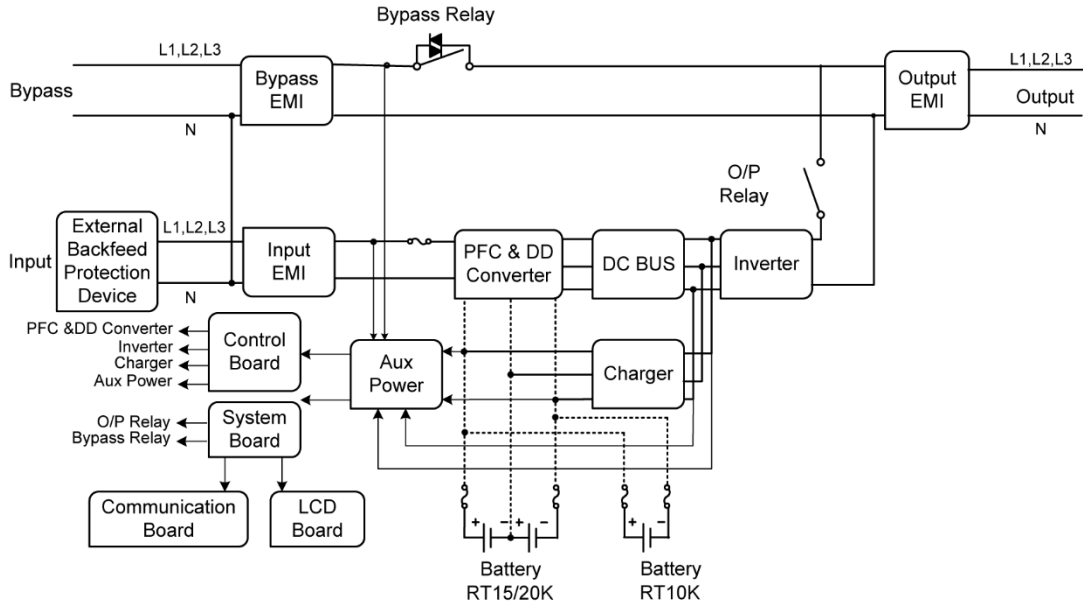

NOTE:

1. The installation method for the UPS models RT-10K3P, RT-15K3P and RT-20K3P is the same. This chapter takes RT 15/20kVA UPS as an example.
2. Before installation, make sure you have understood and followed the important safety instructions in **Chapter 1** thoroughly.
3. The UPS does not have internal batteries and must be connected to the external battery pack(s). See the options below. For details, please refer to **Chapter 8**.

(1) Delta lead-acid battery pack (optional)

For each RT-15K3P and RT-20K3P UPS, please connect two battery packs.

For each RT-10K3P UPS, please connect one battery pack.

(2) Delta lithium-ion battery pack (optional)

For each UPS, please connect one battery pack.

For RT-15K3P and RT-20K3P UPS, please use RT-20K-LIB.

For RT-10K3P UPS, please use RT-10K-LIB.

(3) Customer-owned battery pack (lead-acid battery or others)

See **Table 8-1-1 and Table 8-1-2** for the recommended lead-acid battery quantity.

For more information, refer to Chapter 8. For the installation information and the recommended quantity of other types of batteries, please contact service personnel.

4. Only qualified personnel can perform battery installation. If you want to install the UPS and the external battery pack by yourself, you must be under the supervision of qualified personnel.
5. For external backfeed protection devices, please refer to **Chapter 7.2**.

6.1 Rack Mounting

You can rack-mount the UPS with the Delta standard battery pack (optional) in a standard 19-inch server rack. The mounting kits*¹ and mounting procedures for the UPS and the Delta standard battery pack are the same.



NOTE:

1. *¹ You must use the ear bracket kit provided in the UPS's package and the rail kit (optional) to perform the rack-mounting. Please refer to **Chapter 11** for details about the optional accessories. NEVER use other kits or devices to install the UPS and the Delta standard battery pack.
2. The UPS draws air from its front for ventilation. If your rack has a door on the front, make sure that there is sufficient clearance for air to move freely between the UPS's front side and the rack door.
3. It is strongly recommended that at least two people handle and lift the unit.

● UPS Rack-mounting Procedures

Step 1

Fix two ear brackets to the UPS's two lateral sides with four screws (the ear brackets and screws are in the ear bracket kit provided in the UPS's package). See **Figure 6-1**.

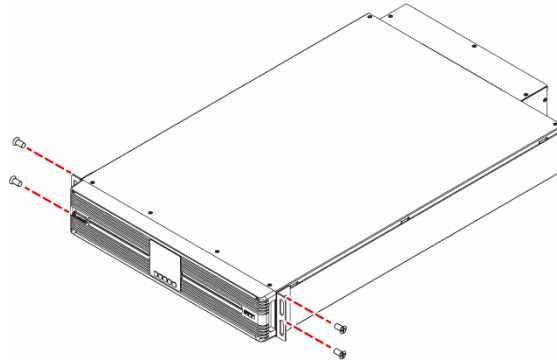

(Figure 6-1: Fix the Ear Brackets)

Step 2

Adjust the length of the rails to fit in your rack and then tighten the nuts (the rails and nuts are provided in the optional rail kit). See **Figure 6-2**.

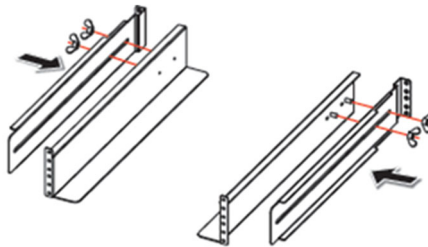

(Figure 6-2: Adjust the Rails & Tighten the Nuts)

Step 3

Use the eight screws and eight washers to fix the rails onto your rack (the screws and washers are provided in the optional rail kit). See **Figure 6-3**.

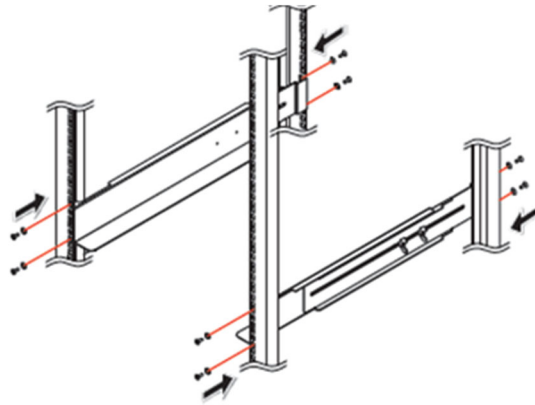

(Figure 6-3: Fix the Rails onto Your Rack)

Step 4

Carefully Insert the UPS into the rack (at least two people are required) and tighten the four screws provided in the ear bracket kit in the UPS's package. See **Figure 6-4**. Please note that there will be extra four nuts left after installation. These four nuts are spare parts for the racks with unthreaded holes.

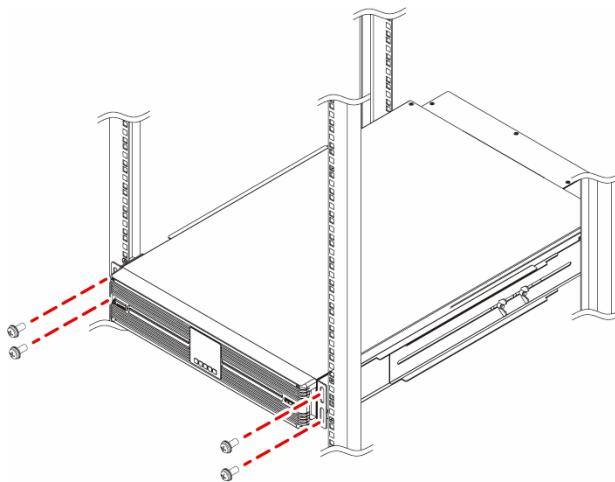

(Figure 6-4: Insert the UPS into Your Rack)

- The above rack-mounting instructions can be applied to both single UPS and parallel UPSs. You can parallel up to four UPSs.
- For the installation methods of the Delta standard battery pack (optional), please also refer to the **User Manual** included in the package of the battery pack.

- Please note that the UPS should be installed beyond the battery pack(s).
- If using Delta lead-acid battery pack, you should connect two to the RT-15K3P and RT-20K3P UPS and one to the RT-10K3P UPS. For more information about the Delta lead-acid battery pack, please refer to **Chapter 8**.

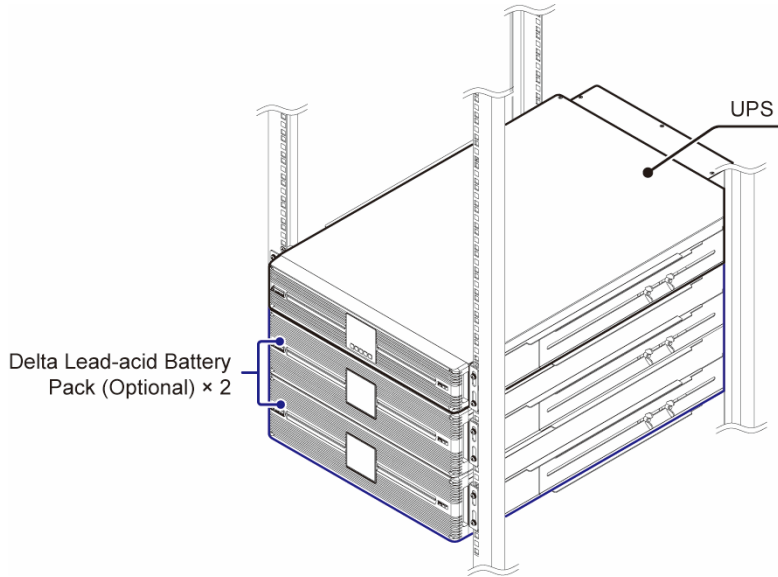

(Figure 6-5: Rack-mount the UPS with Two Delta Lead-acid Battery Packs)

- If using Delta lithium-ion battery pack, you should connect one to the UPS. For RT-15K3P and RT-20K3P UPS, use RT-20K-LIB; for RT-10K3P UPS, use RT-10K-LIB. For more information about the Delta lithium-ion battery pack, please refer to **Chapter 8**.

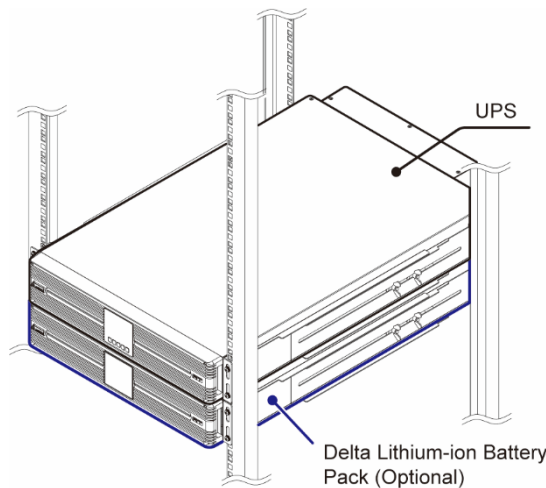

(Figure 6-6: Rack-mount the UPS with One Delta Lithium-ion Battery Pack)

6.2 Tower Mounting

You can tower-mount the UPS with the Delta standard pack (optional) in an upright position. The mounting kits*¹ and mounting procedures for the UPS and the Delta standard battery pack are the same.

The UPS's package provides tower stands only; the tower stand extenders are provided in the package of the optional battery pack. Please refer to **Chapter 11** for details about the optional accessories.



NOTE:

1. *¹ Besides tower stands, you must use the tower stand extenders to perform the tower-mounting for the UPS and Delta standard battery pack.
2. Leave adequate space (at least 15 cm (5.9")) at the front and rear of the UPS for proper ventilation.
3. It is strongly recommended that at least two people handle and lift the unit.

● UPS Tower-mounting Procedures

Step 1

Remove the four screws from the UPS's front plastic panel. See **Figure 6-7**.

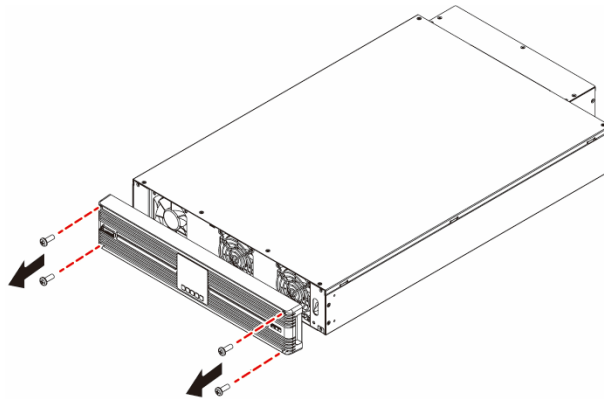

(Figure 6-7: Remove the Front Plastic Panel)

Step 2

Carefully push the backside of the operation panel until the operation panel is detached from the front plastic panel. Please handle with care to avoid damaging the cable which connects the operation panel and the UPS's internal connector. See **Figure 6-8**.

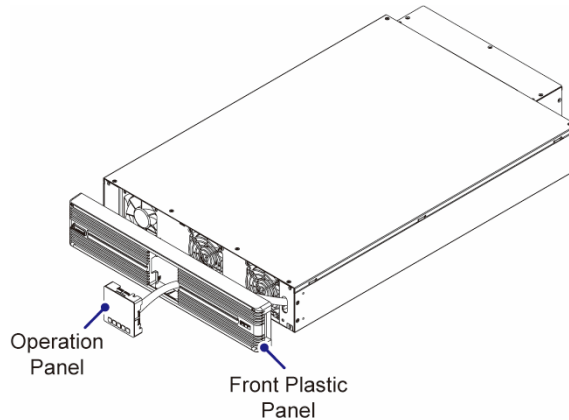

(Figure 6-8: Detach the Operation Panel)

Step 3

Rotate the operation panel 90° clockwise and reinstall it back into the front plastic panel. After that, reinstall the front plastic panel back to the UPS and make sure the four screws are firmly fixed. See **Figure 6-9**.

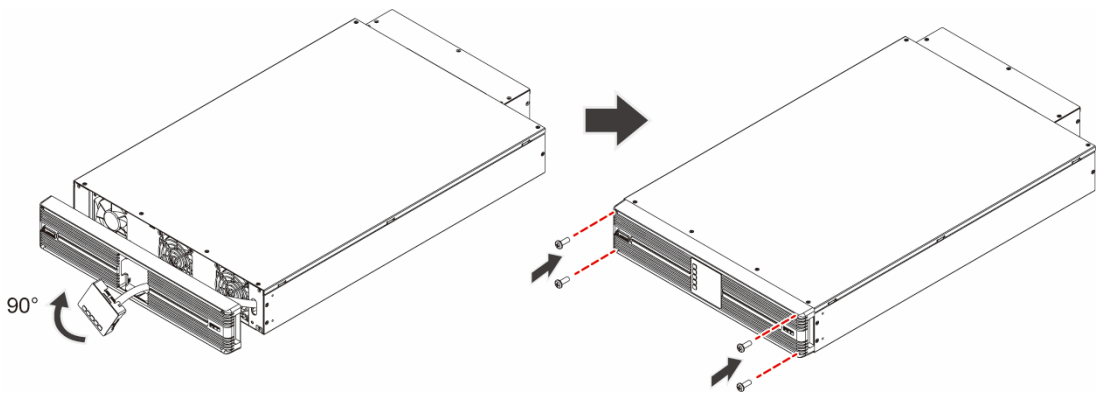

(Figure 6-9: Rotate the Operation Panel 90° Clockwise, Reinstall It Back into the Front Plastic Panel & Reinstall the Front Plastic Panel Back to the UPS)

Step 4

Assemble the tower stands (provided in the UPS's package) by slightly turning and inserting the tenons into the grooves. See **Figure 6-10**.

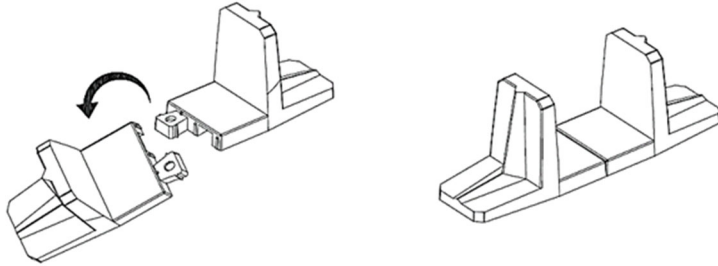

(Figure 6-10: Assemble the Tower Stands)

Step 5

Carefully lift the UPS upright (at least two people are required) with the Delta logo on the front plastic panel facing up. See **Figure 6-11**.

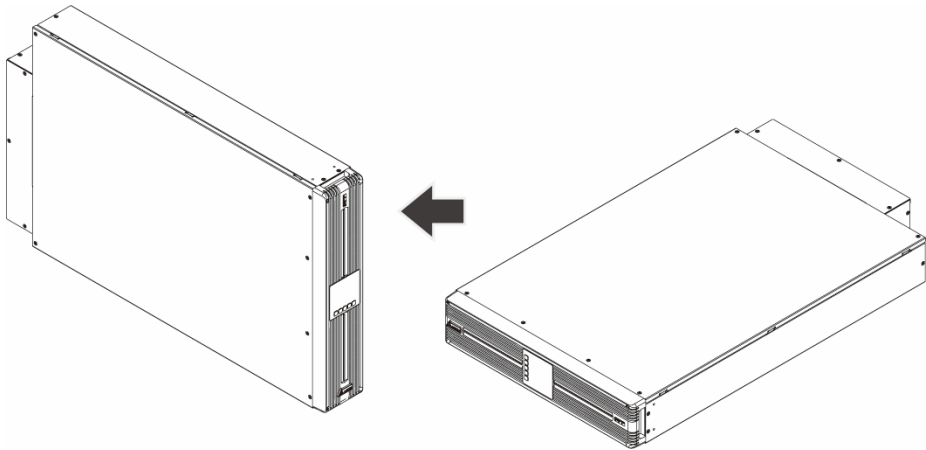

(Figure 6-11: Place the UPS Upright)

Step 6

Fit the UPS into the tower stands (at least two people are required). See **Figure 6-12**.

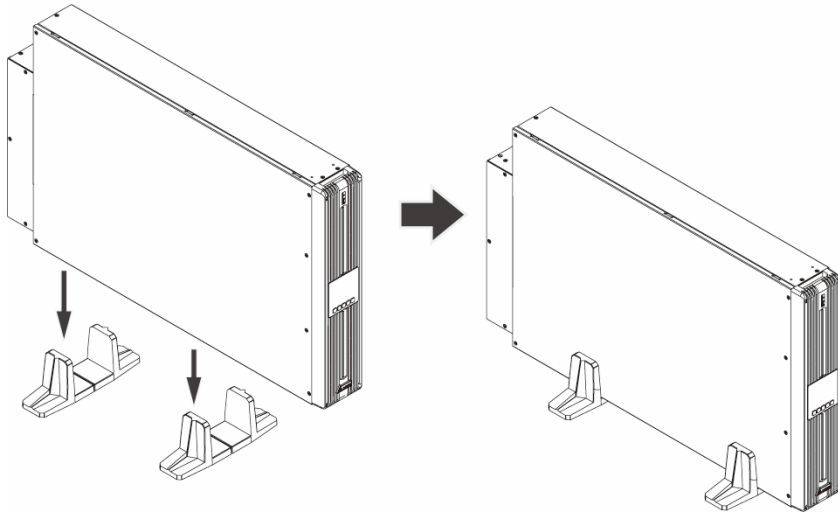

(Figure 6-12: Fit the UPS into the Tower Stands)

- The above tower-mounting instructions can be applied to both single UPS and parallel UPSs. You can parallel up to four UPSs.
- For the installation methods of the Delta standard battery pack (optional), please also refer to the **User Manual** included in the package of the battery pack.
- If using Delta lead-acid battery pack, you should connect two to the RT-15K3P and RT-20K3P UPS and one to the RT-10K3P UPS. For more information about the Delta lead-acid battery pack, please refer to **Chapter 8**.

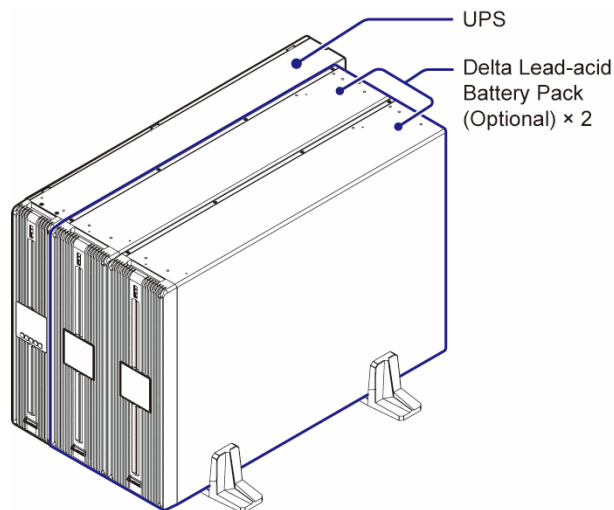

(Figure 6-13: Tower-mount the UPS with Two Delta Lead-acid Battery Packs)

- If using Delta lithium-ion battery pack, you should connect one to the UPS. For RT-15K3P and RT-20K3P UPS, use RT-20K-LIB; for RT-10K3P UPS, use RT-10K-LIB. For more information about the Delta lithium-ion battery pack, please refer to **Chapter 8**.

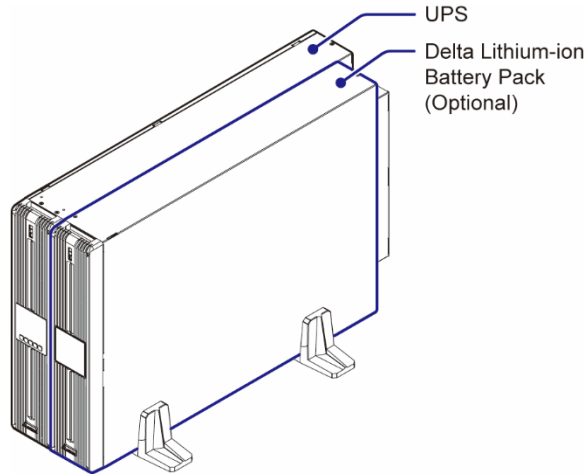

(Figure 6-14: Tower-mount the UPS with One Delta Lithium-ion Battery Pack)

Chapter 7 : UPS Connection

7.1 Pre-connection Warnings

The cables to be connected include main input, bypass input, output and battery cables. When choosing the cables, please follow the local wiring regulations and consider environmental conditions.

Table 7-1 shows the nominal current of the UPS with different phase configurations (three-phase or single-phase). **Table 7-2-1 & Table 7-2-2** list the recommended minimum cross-sectional areas of the cables recommended to the user. Select the appropriate cables according to **Table 7-1** and **Table 7-2-1 ~ Table 7-2-2**.

Only qualified personnel can perform installation, wiring, operation and maintenance. Prior to supplying any power to the UPS, make sure the UPS has been suitably grounded.

Table 7-1: UPS Nominal Current

Model (Input Phase: Bypass Phase: Output Phase)	Nominal Input Phase Current (A)			Nominal Output Phase Current (A)			Nominal Battery Current (A)
	Rated Input Voltage			Rated Output Voltage			
	220/380V	230/400V	240/145V	220/380V	230/400V	240/415V	
RT-10K3P (3P:3P:3P)	Main: 19.4A (3P)	Main: 18.6A (3P)	Main: 17.8A (3P)	15.2A (3P)	14.5A (3P)	13.9A (3P)	58.5A
	Bypass: 18.8A (3P)	Bypass: 18A (3P)	Bypass: 17.15A (3P)				
RT-10K3P (3P:1P:1P)	Main: 19.4A (3P)	Main: 18.6A (3P)	Main: 17.8A (3P)	45.6A (1P)	43.5 (1P)	41.7 (1P)	58.5A
	Bypass: 56.3A (1P)	Bypass: 53.9A (1P)	Bypass: 51.6A (1P)				
RT-15K3P (3P:3P:3P)	Main: 26.4A (3P)	Main: 25.2A (3P)	Main: 24.3A (3P)	22.7A (3P)	21.7A (3P)	20.8A (3P)	44A
	Bypass: 23A (3P)	Bypass: 22A (3P)	Bypass: 21A (3P)				

Model (Input Phase: Bypass Phase: Output Phase)	Nominal Input Phase Current (A)			Nominal Output Phase Current (A)			Nominal Battery Current (A)
	Rated Input Voltage			Rated Output Voltage			
	220/380V	230/400V	240/145V	220/380V	230/400V	240/415V	
RT-15K3P (3P:1P:1P)	Main: 26.4A (3P) Bypass: 69A (1P)	Main: 25.2A (3P) Bypass: 66A (1P)	Main: 24.3A (3P) Bypass: 63A (1P)	68.1A (1P)	65.1A (1P)	62.4A (1P)	44A
RT-20K3P (3P:3P:3P)	Main: 35A (3P) Bypass: 30.6A (3P)	Main: 34.1A (3P) Bypass: 29.3A (3P)	Main: 32.3A (3P) Bypass: 28.1A (3P)	30.3A (3P)	29A (3P)	27.8A (3P)	58A
RT-20K3P (3P:1P:1P)	Main: 35A (3P) Bypass: 91.8A (1P)	Main: 34.1A (3P) Bypass: 87.9A (1P)	Main: 32.3A (3P) Bypass: 84.3A (1P)	90.9A (1P)	87A (1P)	83.4A (1P)	58A



NOTE:

1. A maximum voltage drop allowable for each cable is 4Vac.
2. To avoid electromagnetic interference, do not loop the cable.
3. Connection to non-linear loads will influence your selection of the output and bypass neutral cables; the current of the neutral cable may exceed the rated phase current and can be up to 1.732 times the rated phase current. In such a condition, you have to use cables with larger diameters. Please contact service personnel for more information.

Table 7-2-1: RT-10K3P UPS_ Recommended Minimum Cable Size (Environment Temperature: 25°C (77°F))

Model (InP: ByP: OutP)*1	Input		Bypass		Output		Neutral Line (Input)		Neutral Line (Output)		Battery		Ground					
	mm ²	AWG	mm ²	AWG	mm ²	AWG	mm ²	AWG	mm ²	AWG	mm ²	AWG	mm ²	AWG				
RT-10K3P (3:3:3) Single-source	6	8	N/A		6	8	6	8	6	8	3 × 2 PCS	12 × 2 PCS	6	8				
	3 PCS				3 PCS		2 PCS		2 PCS				6	8				
RT-10K3P (3:3:3) Dual-source	6	8	6	8	6	8	6	8	6	8			3 × 2 PCS	12 × 2 PCS	6	8		
	3 PCS		3 PCS		3 PCS		3 PCS*2		2 PCS						6	8		
RT-10K3P (3:1:1) Single-source	6	8	N/A		6	8	6	8	6	8					3 × 2 PCS	12 × 2 PCS	6	8
	4 PCS				3 PCS		2 PCS		2 PCS								6	8
RT-10K3P (3:1:1) Dual-source	6	8	6	8	6	8	6	8	6	8	3 × 2 PCS	12 × 2 PCS					6	8
	3 PCS		3 PCS		3 PCS		3 PCS*2		2 PCS									
	3 PCS		3 PCS		3 PCS		4 PCS*3		2 PCS									



NOTE:

1. *¹ InP = input phase; ByP = bypass phase; OutP = output phase.
2. *² Connect one main-input neutral wire to an input N terminal and equally distribute the two bypass-input neutral wires to both of the input N terminals.
3. *³ Use two N wires for each power source. Equally distribute the neutral wires of the main AC source and bypass source to both of the input N terminals.

Table 7-2-2: RT-15K3P/ RT-20K3P UPS_ Recommended Minimum Cable Size (Environment Temperature: 25°C (77°F))

Model (InP: ByP: OutP)* ¹	Input		Output		Bypass		Neutral Line		Battery		Ground	
	mm ²	AWG	mm ²	AWG	mm ²	AWG	mm ²	AWG	mm ²	AWG	mm ²	AWG
RT-15K3P (3:3:3)	4	10	4	10	4	10	4	10	10 or 4 × 2PCS	6 or 10 × 2PCS	10	6
RT-15K3P (3:1:1)	4	10	4	10	4	10	4	10			25	2
			3PCS		3PCS		3PCS					
RT-20K3P (3:3:3)	6	8	6	8	6	8	6	8			16	4
RT-20K3P (3:1:1)	6	8	6	8	6	8	6	8	35	1		
			3PCS		3PCS		3PCS					



NOTE:

*¹ Inp = input phase; ByP = bypass phase; OutP = output phase.

7.2 External Protection Device

You must install a circuit breaker (or other protection device) between the main AC source and the UPS; if adopting dual-source input configurations, you must also install a circuit breaker (or other protection device) between the bypass source and the UPS. It is recommended to install a circuit breaker (or other protection device) between the UPS and the output equipment.

This section provides general guidance for qualified installation engineers. A qualified installation engineer should be aware of local wiring regulations and other relevant knowledge.



NOTE:

For the three-phase system, you must use the four-pole protection device; for the single-phase system, you must use the two-pole protection device.

- **Overcurrent Protection**

When installing the UPS, you should consider the current capacity of the power cables and the overload capacity of the system; please refer to **Table 7-1**. For the capacity of the circuit breakers, please refer to **Table 7-3**.

In terms of battery input, if you use the Delta standard battery pack (optional), it already has a built-in overcurrent protection device. However, for customer-owned batteries (lead-acid battery or others), it is required to install a compatible DC circuit breaker for overcurrent protection. For details, please refer to **Table 7-3** and **Chapter 8.4**.

- **Bypass Backfeed Protection**

The UPS comes with built-in bypass backfeed protection devices.

Table 7-3: UPS Protection Device Capacity

Model (Input P: Bypass P: Output P)	Recommended AC Breaker Capacity	Recommended Battery Breaker Capacity
RT-10K3P (3:3:3)	25A/ type D (main) 25A/ type D (bypass) 25A/ type D (output)	63A/ type C
RT-10K3P (3:1:1)	25A/ type D (main) 60A/ type D (bypass) 60A/ type D (output)	63A/ type C
RT-15K3P (3:3:3)	50A/ type D (main) 50A/ type D (bypass) 50A/ type D (output)	63A/ type C
RT-15K3P (3:1:1)	50A/ type D (main) 100A/ type D (bypass) 100A/ type D (output)	63A/ type C
RT-20K3P (3:3:3)	63A/ type D (main) 63A/ type D (bypass) 63A/ type D (output)	63A/ type C (battery rated voltage \geq 216V) 70A/ type C (battery rated voltage $<$ 216V)

Model (Input P: Bypass P: Output P)	Recommended AC Breaker Capacity	Recommended Battery Breaker Capacity
RT-20K3P (3:1:1)	63A/ type D (main) 125A/ type D (bypass) 125A/ type D (output)	63A/ type C (battery rated voltage \geq 216V) 70A/ type C (battery rated voltage $<$ 216V)

- **External Backfeed Protection (for RT-10K3P)**

When the UPS runs in battery mode or during AC power failure, the UPS's inner voltage or energy might be fed back to the input, either directly or via the leakage loop. To avoid the risk of electric shock resulting from the backfeed, an installation of a backfeed protection device between the AC input and the UPS is compulsory.



NOTE:

The warning label shall carry the following wording or equivalent.

Before Working on This Circuit

-Isolate Uninterruptible Power System (UPS)
-Then check for Hazardous Voltage between all terminals including the protective earth.



Risk of Voltage Backfeed

- **Backfeed Protection Wiring Diagram:**

Please refer to the diagram below to install the backfeed protection device between the AC input and the UPS.

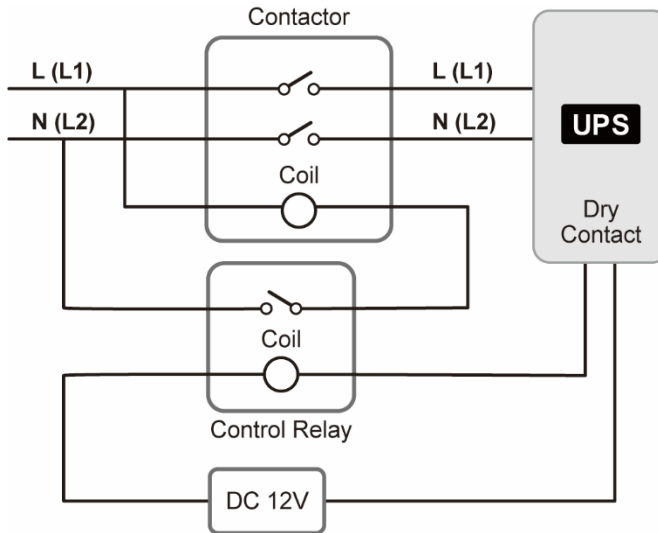

(Figure 7-1: Backfeed Protection Wiring Diagram)

The recommended external backfeed protection devices (with UL certification) are as follows:

Table 7-4: Recommended External Backfeed Protection Devices

UPS	Suggested Rated Voltage/ Current for the Backfeed Protection Device	Suggested Model
RT-10K3P	220/ 230/ 240 Vac 30A	AF40-30-11-13 (ABB)
RT-15K3P	220/ 230/ 240 Vac 50A	AF40-30-11-13 (ABB)
RT-20K3P	220/ 230/ 240 Vac 63A	AF52-30-11-13 (ABB)

The information of the recommended control relay for the external backfeed protection devices is as follows:

Table 7-5: Information of the Recommended Control Relay for the External Backfeed Protection Devices

Breaking Capacity	240 Vac/ 5A
Contact Form	Normally Closed (NC)
Coil	12 Vdc/ < 0.5A
Suggested Model Number	HF 13F-012-1Z1T

7.3 UPS Wiring

The UPS wiring cables need to be connected to the AC input, bypass input, battery input, AC output and grounding terminals, which you can see after removing the upper cover at the rear of the UPS.

See **Figure 7-2** and **Figure 7-3**.

The upper cover tightening torque when installing is 0.78 N.m (6.9 in-lbs).

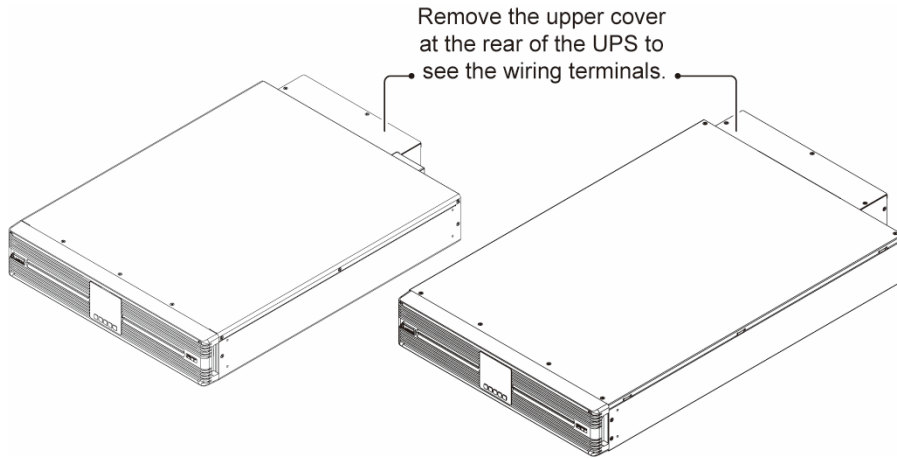



(Figure 7-2: Location of the Upper Cover at Rear)

The UPS's wiring terminals are shown in **Figure 7-3**.

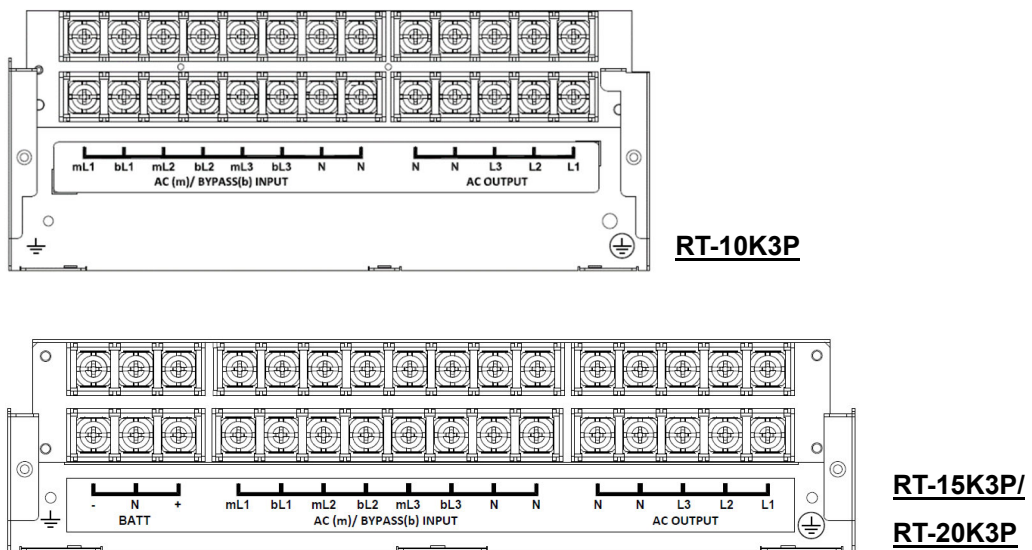
The wiring tightening torque is 2.9 N.m (26 in-lbs).



(Figure 7-3: UPS's Wiring Terminals)

No.	Item (Printed Words on the UPS Rear Panel)	Description	Function
1	AC (m) INPUT	AC input terminals, including mL1/ mL2/ mL3/ N*1 terminals.	Connected to the main AC source.
2	BYPASS (b) INPUT	Bypass input terminals, including bL1/ bL2/ bL3/ N*1 terminals.	Connected to the bypass source*2.
3	AC OUTPUT	UPS output terminals, Including L1/ L2/ L3/ N terminals.	Connected to the critical loads.
4	BATT (Only for RT-15K3P & RT-20K3P UPS)*3	Battery input terminals, including -/ N/ + terminals.	Connected to the external battery pack(s).
5		PE (protective earth) terminal	Protective earthing for protection against electrical shock in case of fault*4. The terminal must be connected to the main earth.
6		GND (ground) terminal	The terminal is used to ground the devices, which are associated with UPS operation.



NOTE:

1. *1 For dual-source input configurations, the main AC source and bypass source must use the same neutral (N).
2. *2 For the UPS with dual-source input configurations only.
3. *3 For the connection to the external battery pack for RT-10K3P, please refer to **page 22**.
4. *4 The PE (protective earth) connection ensures that all exposed conductive surfaces are at the same electric potential as the Earth to avoid the risk of electrical shock due to leakage current or an insulation fault.

7.3.1 RT-10K3P UPS_ Three-phase Single-source Input & Single-phase Output



NOTE:

The quantity of wires mentioned below is based on **Table 7-2-1** for your reference.

1. Install the bus bars according to **Figure 7-4**.
2. Connect the main AC source (L1/ L2/ L3/ N): connect two L1 wires to **mL1**, **bL1**, **bL2**, or **bL3**; one L2 wire to **mL2**; one L3 wire to **mL3**; and two N wires to both of the **N** terminals.
3. Connect the external battery pack to the battery connector (+/-) at the rear panel of the UPS.
- Refer to **Chapter 8.5.1**.
4. Connect the single-phase loads (L/ N): connect three L wires to **L1**, **L2**, and **L3** respectively and two N wires to both of the **N** terminals.

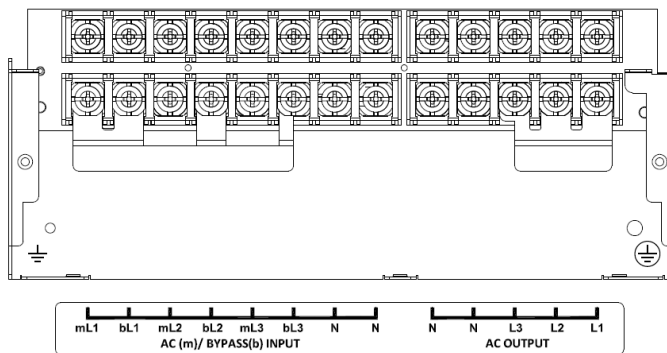

(Figure 7-4: Bus Bar Installation_ Three-phase Single-source Input & Single-phase Output)

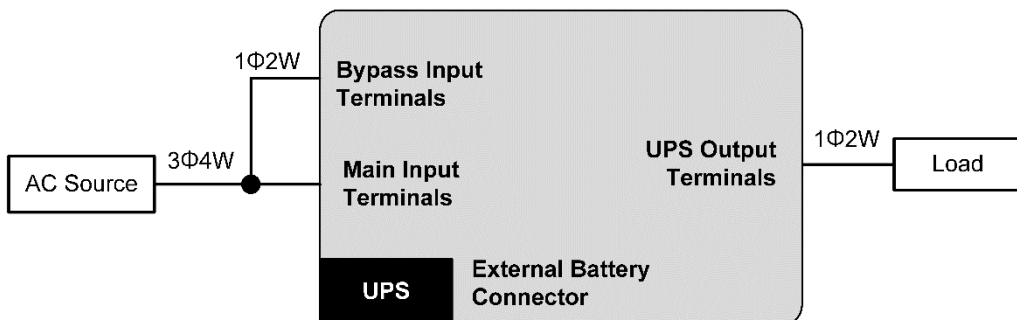

(Figure 7-5: UPS Wiring Diagram_ Three-phase Single-source Input & Single-phase Output)

7.3.2 RT-10K3P UPS_ Three-phase Dual-source Input & Single-phase Output



NOTE:

The quantity of wires mentioned below is based on **Table 7-2-1** for your reference.

1. Install the bus bars according to **Figure 7-6**.
2. Connect the main AC source (L1/ L2/ L3/ N): connect one L1 wire to **mL1**, one L2 wire to **mL2**, one L3 wire to **mL3**, and one N wire to one of the **N** terminals.
3. Connect the bypass source (L/ N): connect three L wires to **bL1**, **bL2**, and **bL3** respectively and two N wires to both of the N terminals.
4. Connect the external battery pack to the battery connector (+/-) at the rear panel of the UPS. Refer to **Chapter 8.5.1**.
5. Connect the single-phase loads (L/ N): connect three L wires to **L1**, **L2**, and **L3** respectively and two N wires to both of the **N** terminals.

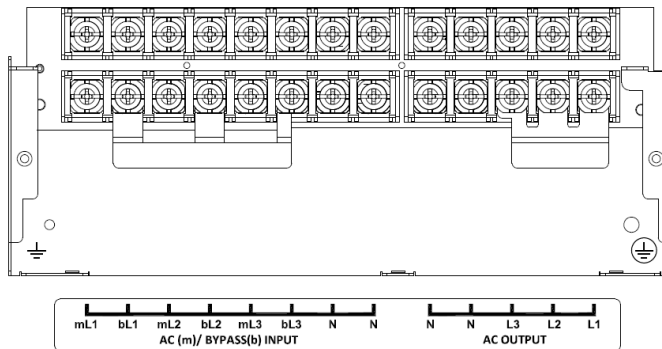

(Figure 7-6: Bus Bar Installation_ Three-phase Dual-source Input & Single-phase Output)

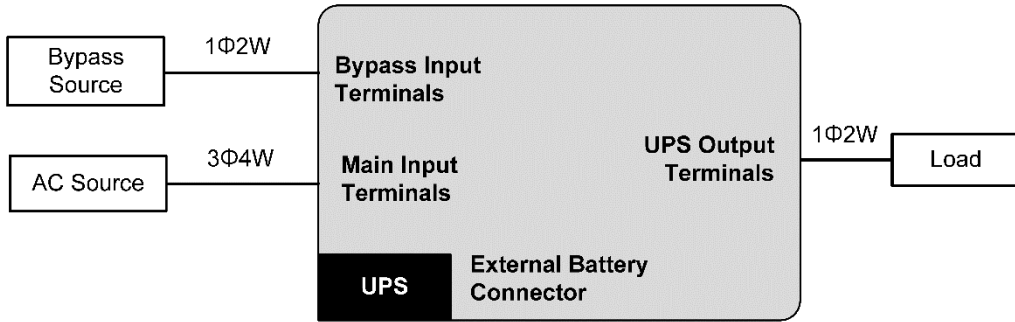

(Figure 7-7: UPS Wiring Diagram_ Three-phase Dual-source Input & Single-phase Output)

7.3.3 RT-10K3P UPS_ Three-phase Single-source Input & Three-phase Output



NOTE:

The quantity of wires mentioned below is based on **Table 7-2-1** for your reference.

1. Install the bus bars according to **Figure 7-8**.
2. Connect the main AC source (L1/ L2/ L3/ N): connect one L1 wire to **mL1** or **bL1**, one L2 wire to **mL2** or **bL2**, one L3 wire to **mL3** or **bL3**, and two N wires to both of the **N** terminals.
3. Connect the external battery pack to the battery connector (+/-) at the rear panel of the UPS. Refer to **Chapter 8.5.1**.
4. Connect the three-phase loads (L1/ L2/ L3/ N): connect one L1 wire to **L1**, one L2 wire to **L2**, one L3 wire to **L3**, and two N wires to both of the **N** terminals.

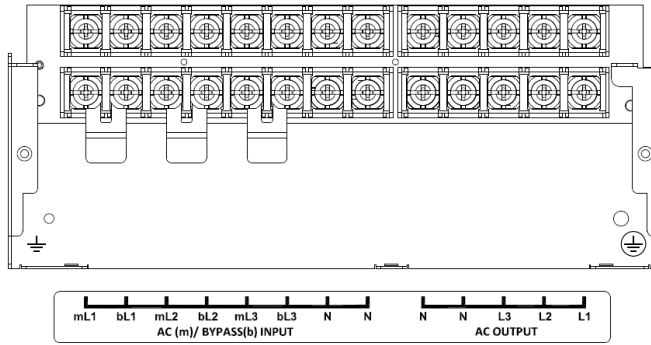

(Figure 7-8: Bus Bar Installation_ Three-phase Single-source Input & Three-phase Output)

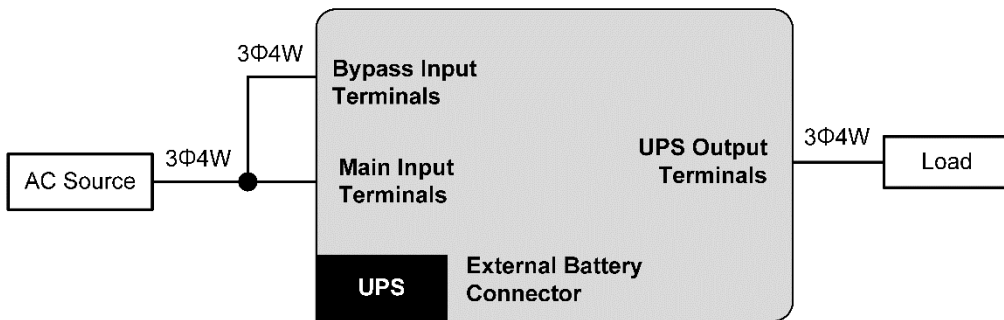

(Figure 7-9: UPS Wiring Diagram_ Three-phase Single-source Input & Three-phase Output)

7.3.4 RT-10K3P UPS_ Three-phase Dual-source Input & Three-phase Output



NOTE:

The quantity of wires mentioned below is based on **Table 7-2-1** for your reference.

1. Install the bus bars according to **Figure 7-10**.
 2. Connect the main AC source (L1/ L2/ L3/ N): connect one L1 wire to **mL1**, one L2 wire to **mL2**, one L3 wire to **mL3**; and one N wire to one of the **N** terminals.
 3. Connect the bypass source (L1/ L2/ L3/ N): connect one L1 wire to **bL1**, one L2 wire to **bL2**, one L3 wire to **bL3**, and two N wires to both of the **N** terminals.
 4. Connect the external battery pack to the battery connector (+/ -) at the rear panel of the UPS.
- Refer to **Chapter 8.5.1**.
5. Connect the three-phase loads (L1/ L2/ L3/ N): connect one L1 wire to **L1**, one L2 wire to **L2**, one L3 wire to **L3**, and two N wires to both of the **N** terminals.

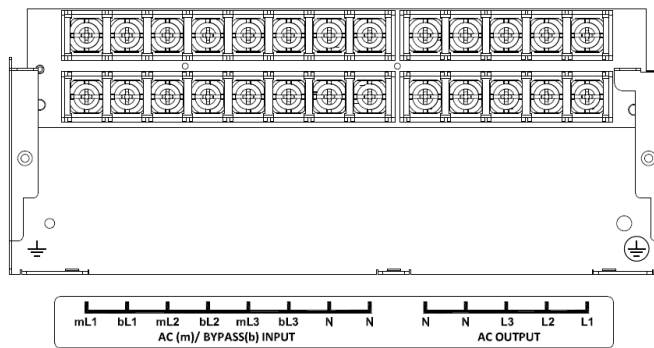

(Figure 7-10: Bus Bar Installation_ Three-phase Dual-source Input & Three-phase Output)

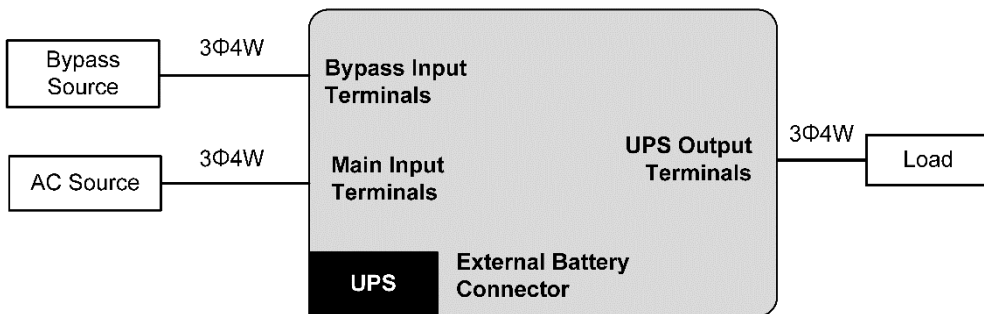

(Figure 7-11: UPS Wiring Diagram_ Three-phase Dual-source Input & Three-phase Output)

7.3.5 RT-15K3P and RT-20K3P UPS_ Three-phase Single-source Input & Single-phase Output

1. Install the bus bars according to **Figure 7-12**.
2. Connect the main AC source (L1/ L2/ L3/ N): connect L1 to **mL1**, **bL1**, **bL2**, or **bL3**; L2 to **mL2**; L3 to **mL3**; and N to one of the **N** terminals.
3. Connect the external battery pack(s): connect the battery -/ N/ + to -/ **N**/ +.
4. Connect the single-phase loads' L to **L1**, **L2**, or **L3** and the loads' N to one of the **N** terminals.

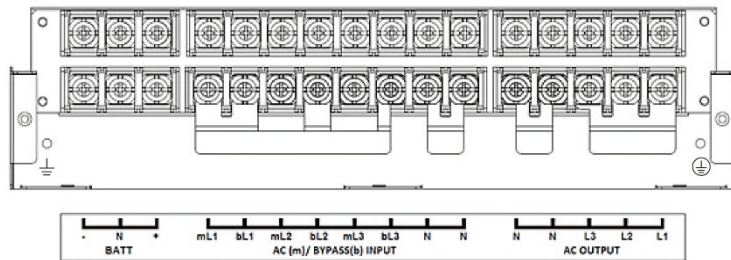

(Figure 7-12: Bus Bar Installation_ Three-phase Single-source Input & Single-phase Output)

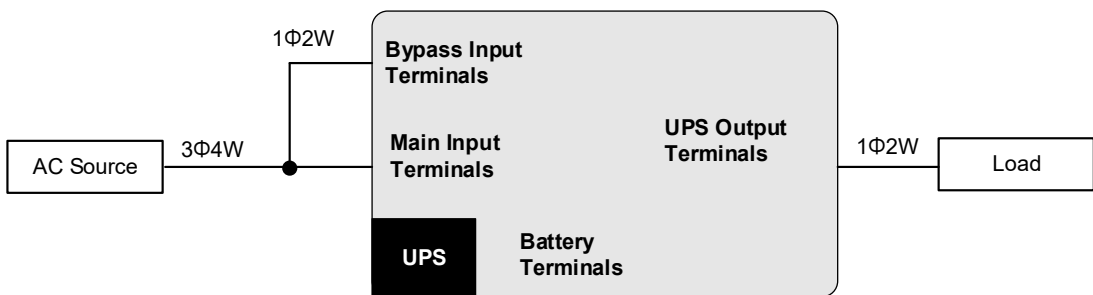

(Figure 7-13: UPS Wiring Diagram_ Three-phase Single-source Input & Single-phase Output)

7.3.6 RT-15K3P and RT-20K3P UPS_ Three-phase Dual-source Input & Single-phase Output

1. Install the bus bars according to **Figure 7-14**.
2. Connect the main AC source (L1/ L2/ L3/ N): connect L1 to **mL1**; L2 to **mL2**; L3 to **mL3**; N to one of the **N** terminals.
3. Connect the bypass source (L/ N): connect L to **bL1**, **bL2**, or **bL3**.
4. Connect the external battery pack(s): connect the battery -/ N/ + to -/ **N**/ +.
5. Connect the single-phase loads' L to **L1**, **L2**, or **L3** and the loads' N to one of the **N** terminals.

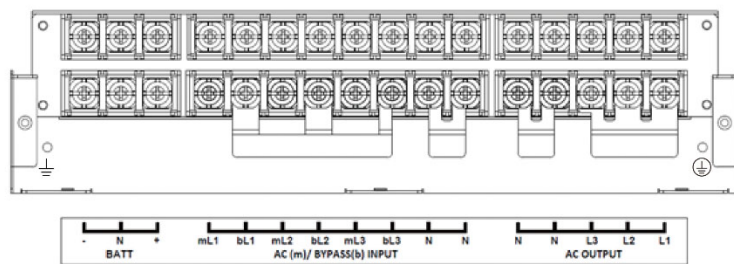

(Figure 7-14: Bus Bar Installation_ Three-phase Dual-source Input & Single-phase Output)

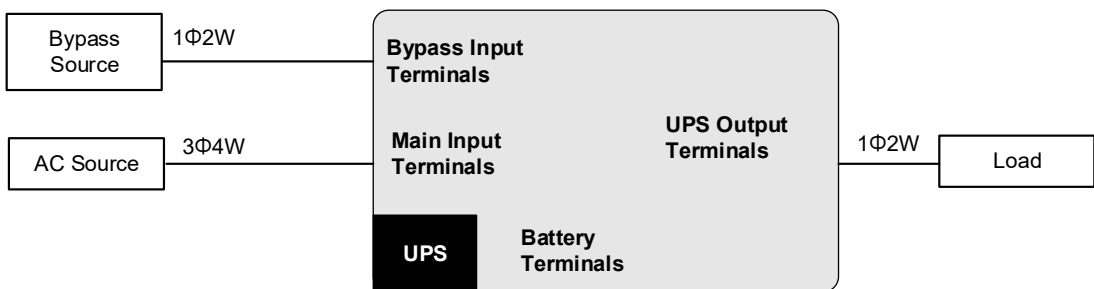

(Figure 7-15: UPS Wiring Diagram_ Three-phase Dual-source Input & Single-phase Output)

7.3.7 RT-15K3P and RT-20K3P UPS_ Three-phase Single-source Input Output & Three-phase Output

1. Install the bus bars according to **Figure 7-16**.
2. Connect the main AC source (L1/ L2/ L3/ N): connect L1 to **mL1** or **bL1**; L2 to **mL2** or **bL2**; L3 to **mL3** or **bL3**; and N to one of the **N** terminals.
3. Connect the external battery pack(s): connect the battery -/ N/ + to -/ **N**/ +.
4. Connect the three-phase loads' L1/ L2/ L3 to **L1**/ **L2**/ **L3** respectively and the loads' N to one of the **N** terminals.

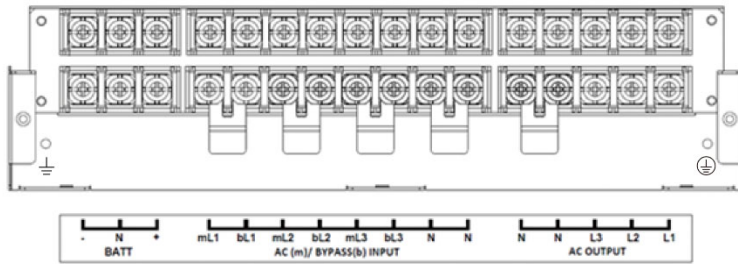

(Figure 7-16: Bus Bar Installation_ Three-phase Single-source Input & Three-phase Output)

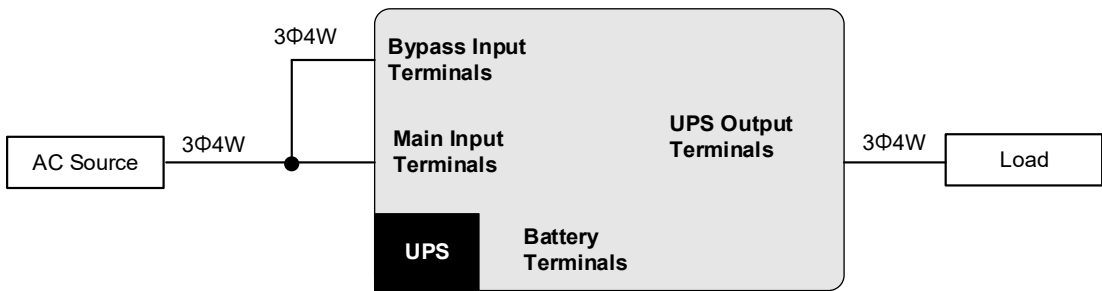

(Figure 7-17: UPS Wiring Diagram_ Three-phase Single-source Input & Three-phase Output)

7.3.8 RT-15K3P and RT-20K3P UPS_ Three-phase Dual-source Input & Three-phase Output

1. Install the bus bars according to **Figure 7-18**.
2. Connect the main AC source (L1/ L2/ L3/ N): connect L1 to **mL1**; L2 to **mL2**; L3 to **mL3**; and N to one of the **N** terminals.
3. Connect the bypass source (L1/ L2/ L3/ N): connect L1 to **bL1**; L2 to **bL2**; and L3 to **bL3**.
4. Connect the external battery pack(s): connect the battery -/ N/ + to the -/ **N**/ +.
5. Connect the three-phase loads' L1/ L2/ L3 to **L1/ L2/ L3** respectively and the loads' N to one of the **N** terminals.

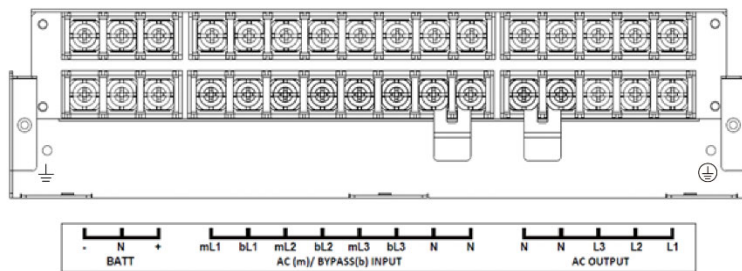

(Figure 7-18: Bus Bar Installation_ Three-phase Dual-source Input & Three-phase Output)

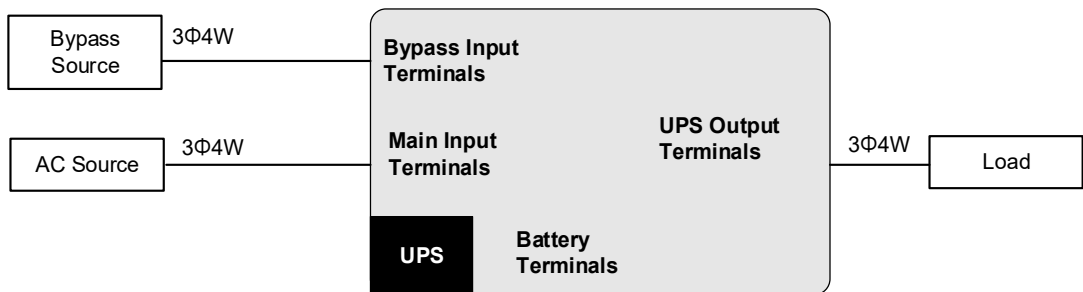

(Figure 7-19: UPS Wiring Diagram_ Three-phase Dual-source Input & Three-phase Output)

7.3.9 UPS Grounding Terminal (⊕) Locking Method

To ensure the UPS's earthing protection, when performing the earthing and bonding procedures, please follow steps 1 ~ 2 and the sequence ① ~ ⑥*¹ in **Figure 7-20** below.



NOTE:

*¹ The components ① ~ ⑥ in **Figure 7-20** are not provided in the UPS's package. Users should prepare the protective earthing terminal, protective bonding terminal, lock washers and nuts.

Step 1

For protective earthing, fix the protective earthing terminal (①) with a lock washer first (②) and then with a nut (③). The earthing terminal (①) connects to the main AC source grounding (and bypass source grounding if you adopt dual-source configurations).

Step 2

For protective bonding, fix the protective bonding terminal (④) with a lock washer first (⑤) and then with a nut (⑥). The bonding terminal (④) connects to the load grounding.

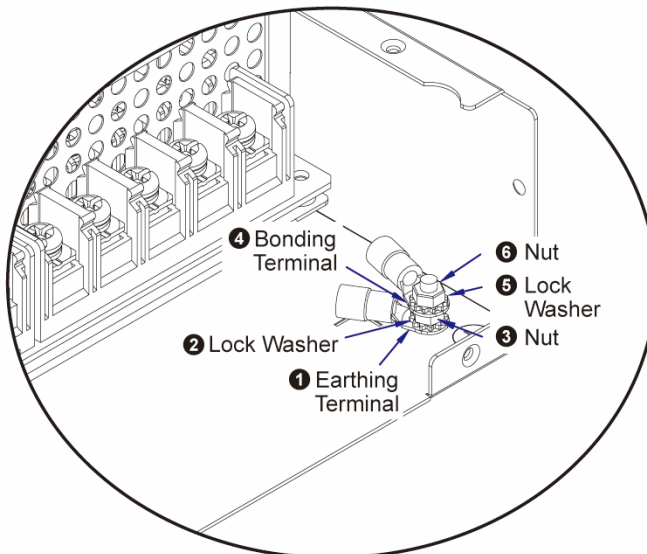

(Figure 7-20: UPS Grounding Terminal (⊕)_ Earthing Terminal & Bonding Terminal Locking Method)

7.4 Parallel Units Wiring



NOTE:

1. You can parallel four UPSs at most. Please use the provided parallel cable. We recommend you adopt the Daisy Chain method for parallel cable connection.
2. Please make sure the wiring of all the UPSs is properly connected and all the external protection devices (breakers) are in the 'OFF' position.
3. For the parallel UPSs, the diameters and lengths of each unit's input cables and output cables must be equal. This ensures that the parallel UPSs can equally share the loads when in bypass mode.
4. Before starting up the parallel UPSs, make sure each parallel UPS has been assigned a different ID number and the parameter settings in **Table 7-6** among the parallel UPSs must be consistent. Otherwise, the parallel operation will fail. For details about parameter settings, please refer to **Chapter 10.2.2**.
5. The parallel UPSs must adopt the same output phase configurations.
6. Ensure that the parallel UPSs are completely turned on before you start up the loads. Please turn on the high-power loads first to avoid triggering overload protection.
7. Common battery function can only be applied to parallel UPSs connecting to the same battery packs. For details, please refer to **Chapter 7.4.3**.

Table 7-6: Parameter Settings for Parallel UPSs

Setup Item (Level 2)	Parameter (Level 3)
Output	Output Phase
	Output Voltage
	Output Frequency
	Output Sync. Freq. Range
	Output Freq. Slew Rate
	Output Mode
Input	Bypass Max. Voltage
	Bypass Min. Voltage

Setup Item (Level 2)	Parameter (Level 3)
ECO Mode	ECO Mode
	ECO Max. Voltage
	ECO Min. Voltage
Parallel	Redundant UPS
	ID*1
	Common Battery
On/Off Settings	Energy Saving
	Auto Restart
	Auto Start on AC
Battery	Automatic Battery Test*2
	Deep Discharge Test*2
	Low Battery Warning Capacity*2
	Warning of Remaining Time*2
	Runtime Limitation*2
	Charge Mode*2
	Internal Charging Current*2
	External Battery Source*2
	External Battery Type*2
	Rated Voltage*2
	Total Capacity*2
	Float Charging Voltage*2
	EOD Voltage*2
Install Date*2	
Dry Contact Setting	Dry Contact 1 - Input
	Dry Contact 2 - Output
	Dry Contact 3 - Output
	Dry Contact 4 - Output
	Remote Control



NOTE:

- *1 The selectable ID numbers are '1, 2, 3 and 4'. Each parallel UPS should be assigned a different ID.
- *2 You should set these items the same among the parallel UPSs only when 'Common Battery' is set as 'Yes'.

7.4.1 Parallel Wiring for Single Input

- For information of the single input configurations of RT-10K3P UPS, please refer to **Chapter 7.3.1** and **Chapter 7.3.3** for that of RT-15K3P and RT-20K3P UPS, please refer to **Chapter 7.3.5** and **Chapter 7.3.7**.
- Use the provided parallel cables and follow **Figure 7-21** to connect the parallel ports.
- Refer to **Chapter 7.3.9** to lock the earthing and bonding terminals on the UPS's grounding terminal (⊕). For the grounding terminal location, see **Figure 7-3**.

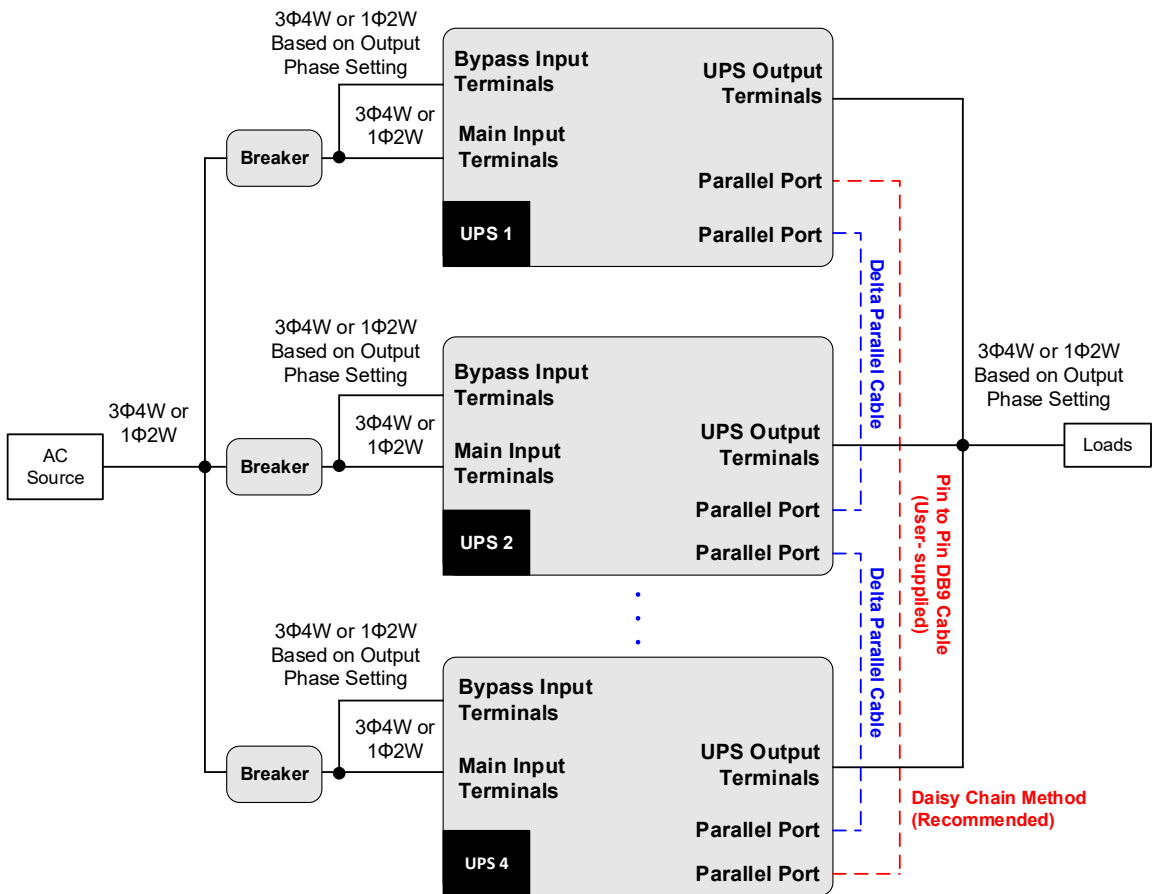

(Figure 7-21: Parallel Wiring Diagram_ Single Input)

7.4.2 Parallel Wiring for Dual Input

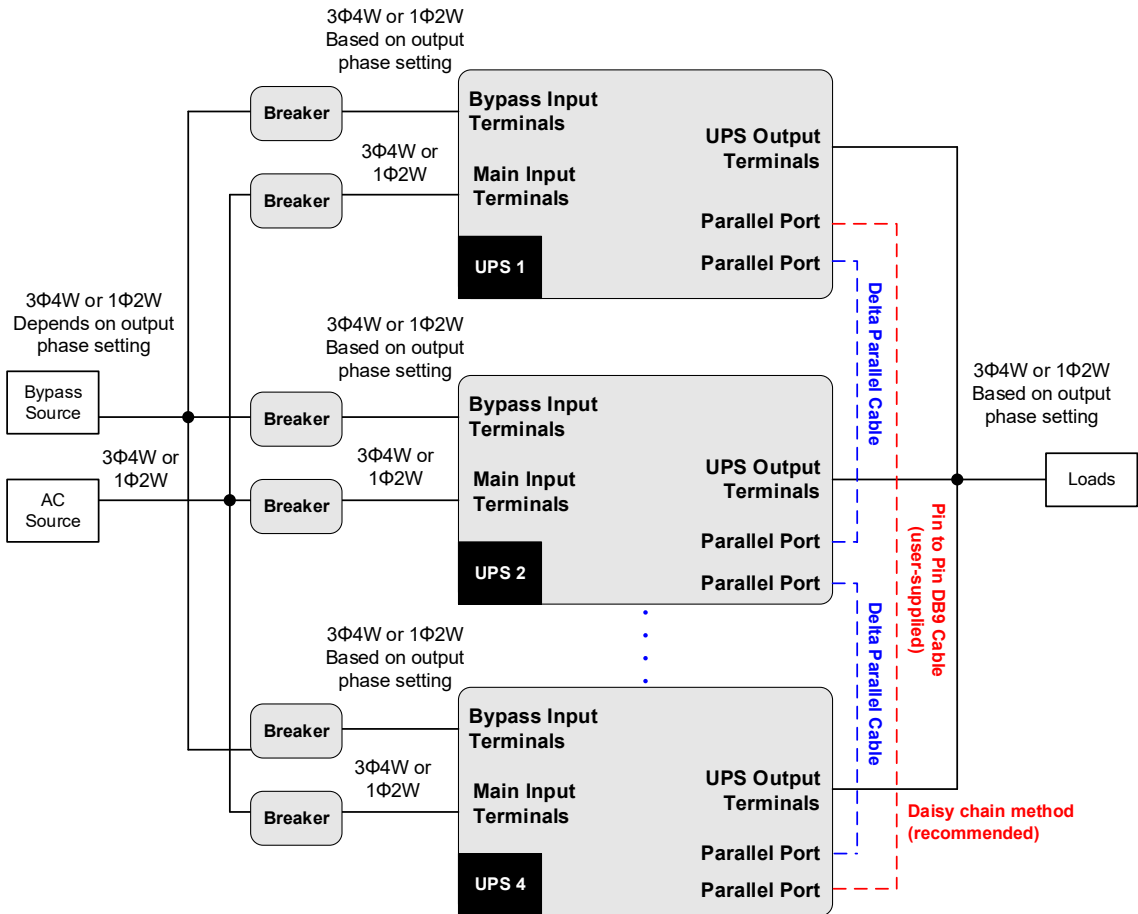

1. For information of the dual input configurations of RT-10K3P UPS, please refer to **Chapter 7.3.2 and Chapter 7.3.4** for that of RT-15K3P and RT-20K3P UPS, please refer to **Chapter 7.3.6 and Chapter 7.3.8**.
2. Use the provided parallel cables and follow **Figure 7-22** to connect the parallel ports.
3. Refer to **Chapter 7.3.9** to lock the earthing and bonding terminals on the UPS's grounding terminal (\oplus). For the grounding terminal location, see **Figure 7-3**.



(Figure 7-22: Parallel Wiring Diagram_ Dual Input)

7.4.3 Wiring for Common Battery (Only for RT-15K3P and RT-20K3P UPS)

When two or more UPSs are connected in parallel, in order to reduce costs and save installation space, the parallel UPSs can share the same lead-acid battery packs. Note that a circuit breaker must be installed between each UPS and each connected external battery pack. Refer to **Figure 7-23** and **Figure 7-24**.

To enable the common battery function, press the Enter button () for 0.1 second → select 

→ select **Parallel** → set the **Common Battery** to 'Yes'.

For setting details, please refer to **Table 7-6** and **Chapter 10.2.2**.



NOTE:

1. The common battery function is not applicable to lithium-ion batteries.
2. When connecting a customer-owned battery pack to the UPS, you must install an appropriate DC breaker or fast-acting fuses that meets the safety certification.
3. Do not use an AC breaker. The breaker must be 2-pole with 1-pole 250Vdc, 2-pole 500Vdc, and 10kA (or above) DC breaking capacity. Please refer to **Table 7-3**.

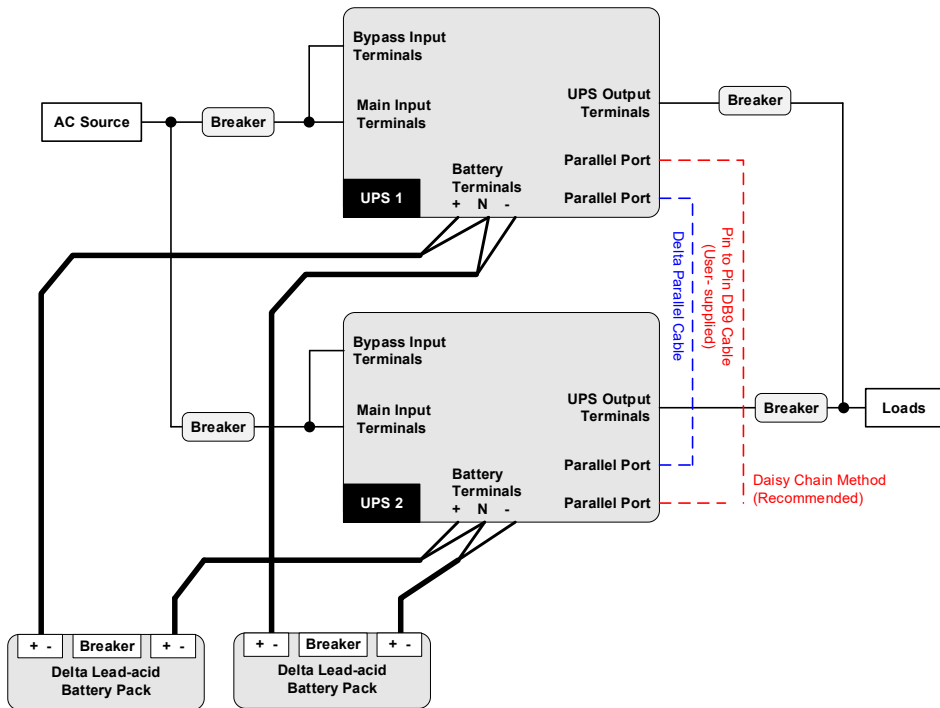

(Figure 7-23: Common Battery Wiring Diagram_ Two Parallel UPSs Sharing Two Delta Lead-acid Battery Packs)

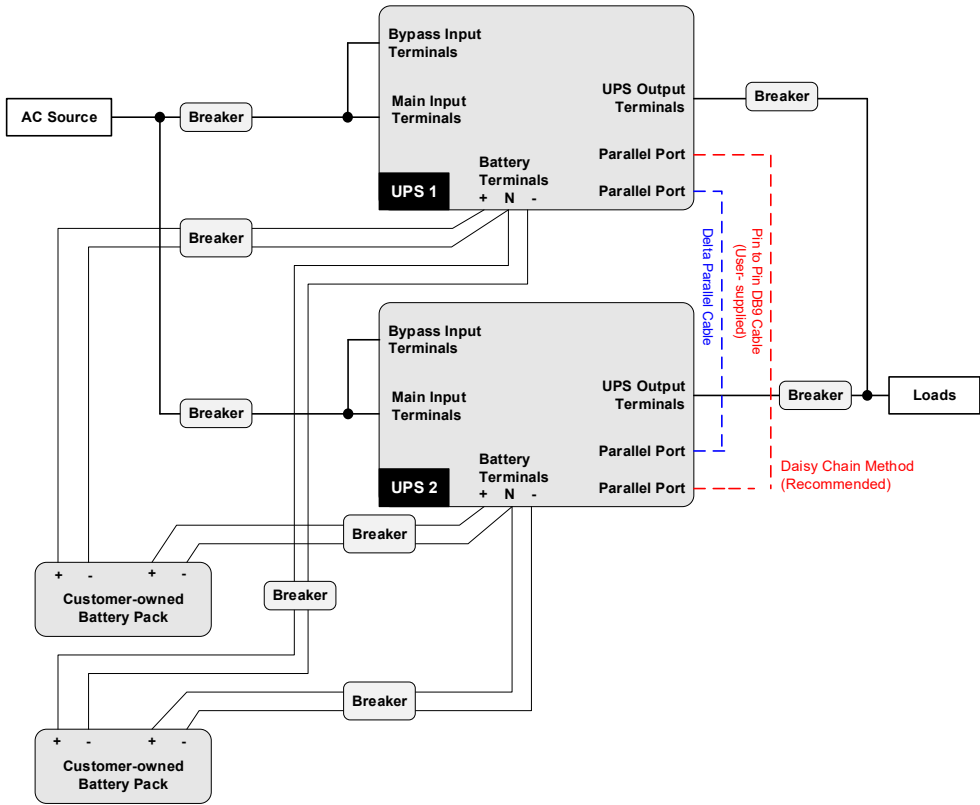

(Figure 7-24: Common Battery Wiring Diagram_ Two Parallel UPSs Sharing Two Customer-owned Lead-acid Battery Packs)

7.5 Connection to the Optional Maintenance Bypass Box (MBB)_ for Single UPS

For the MBB connection, the power cables and cable glands are installed on the UPS before the UPS is shipped*1, as shown in **Figure 7-25**.

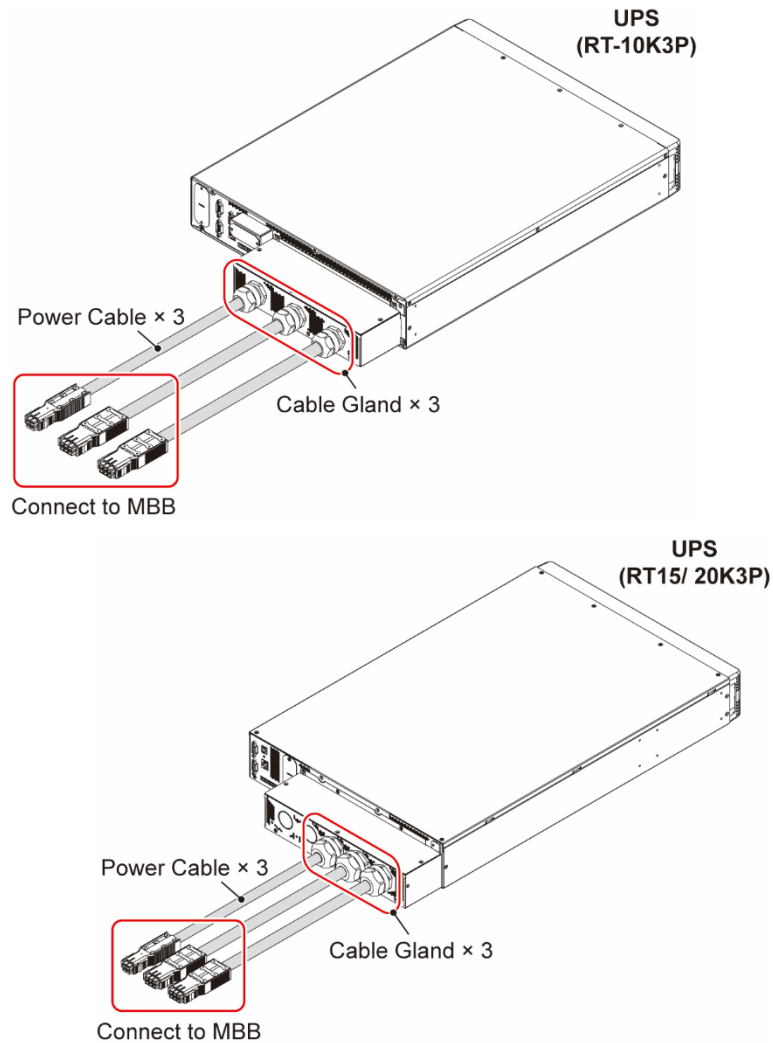

(Figure 7-25: Power Cables and Cable Glands Installed before Shipment)



NOTE:

*1 This depends on different UPS model requirements. Please see the information below.

As the MBB is optional, if the UPS model purchased by users does not have power cables and cable glands installed on the UPS before shipment, the three power cables*¹ will need to be connected to the UPS's wiring terminals (including the AC input terminals, bypass input terminals, UPS output terminals and grounding terminal (⊕)) according to the instructions of the MBB's **User Manual**. For details about the UPS's wiring terminals, please refer to **Chapter 7.3**. Note that the connection should be performed by qualified service personnel.



NOTE:

*¹ The power cables are provided in the MBB's package but users should prepare the cable glands.

After connection to the UPS's wiring terminals, please follow the steps below and reference the MBB's **User Manual** to connect the UPS with the MBB.

Step 1

Plug the three power cables into the connectors (①), (②) and (③) of the MBB.

Step 2

Use the MBB communication cable (④, provided in the MBB's package) to connect the MBB's MBS port and the UPS's parallel port.

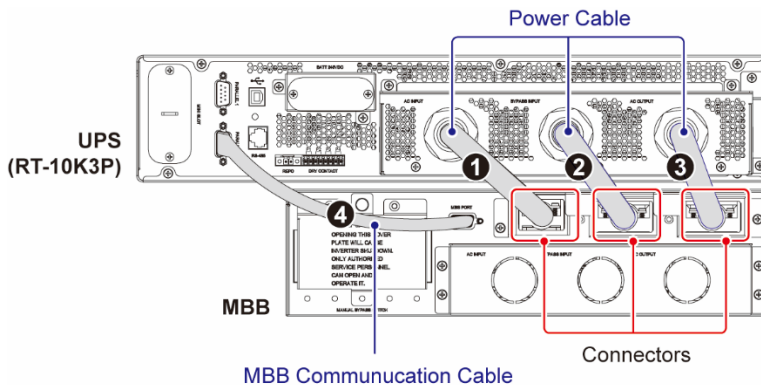

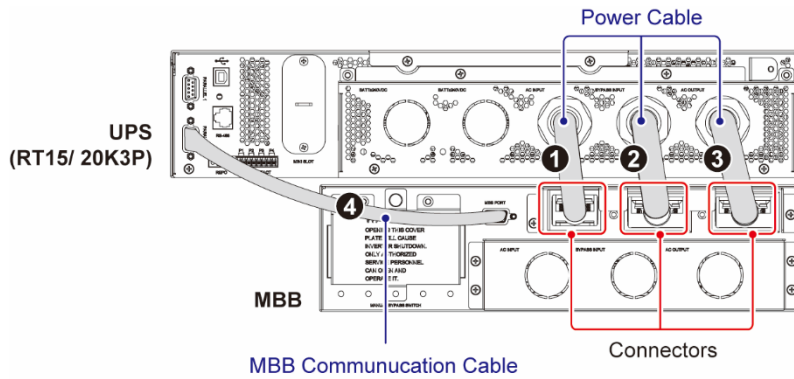

(Figure 7-26: Connect the UPS with the MBB)

7.6 Connection to the Optional Power Distribution Box (PDB)_ for Single UPS/ Parallel UPSs

For the PDB connection, the power cables and cable glands are installed on the UPS before the UPS is shipped*1, as shown in **Figure 7-27**.

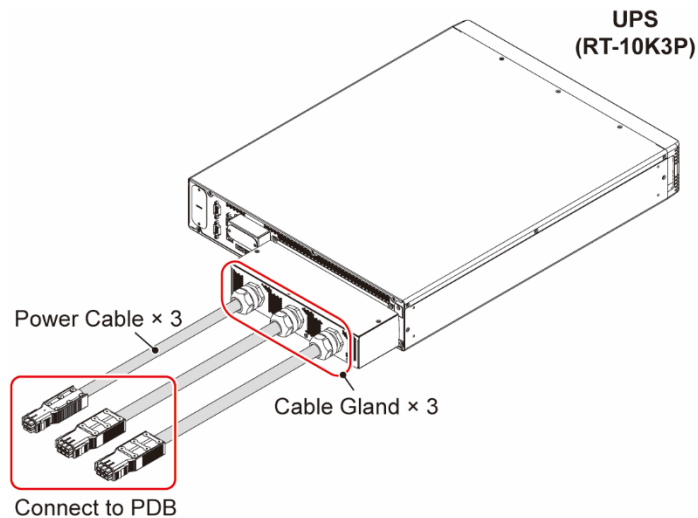

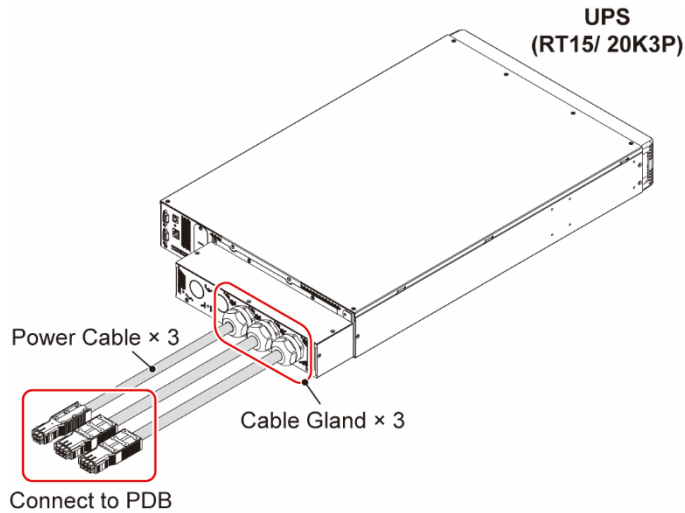

(Figure 7-27: Power Cables and Cable Glands Installed before Shipment)



NOTE:

*1 This depends on different UPS model requirements. Please see the information below.

As the PDB is optional, if the UPS model purchased by users does not have the power cables and cable glands installed on the UPS before shipment, the three power cables*1 will need to be connected to the UPS's wiring terminals (including the AC input terminals, bypass input terminals, UPS output terminals and grounding terminal (⊕)) according to the instructions of the PDB's **User Manual**. For details about the UPS's wiring terminals, please refer to **Chapter 7.3**. Note that the connection should be performed by qualified service personnel.



NOTE:

*1 The power cables are provided in the PDB's package but users should prepare the cable glands.

After connection to the UPS's wiring terminals, please follow the steps below and reference the PDB's **User Manual** to connect the UPS with the PDB. The PDB can be connected to one UPS or two parallel UPSs. The illustration below is an example of one PDB connected to two parallel UPSs.

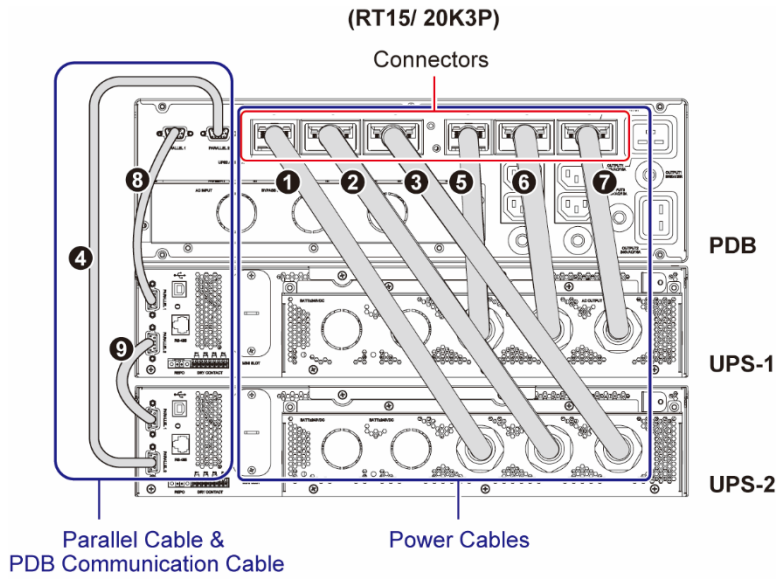
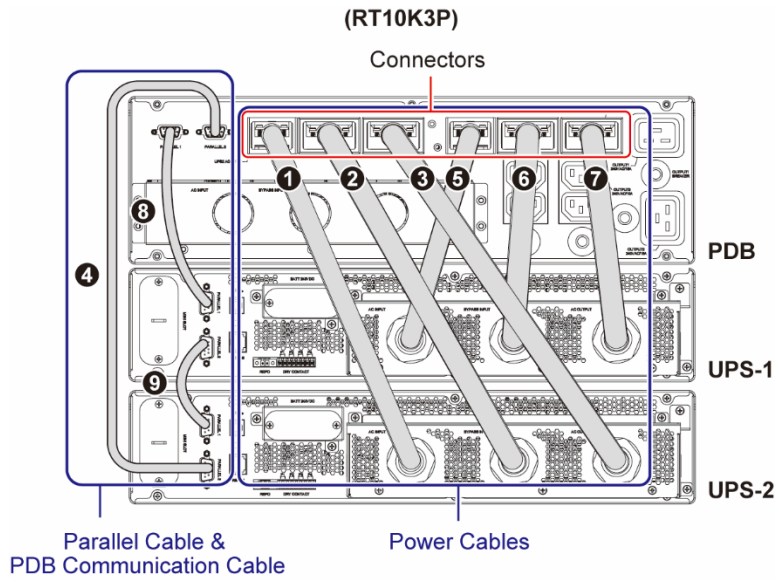

(Figure 7-28: Connect the UPS with the PDB)

Step 1

Plug the three power cables of the UPS 2 into the connectors (❶), (❷) and (❸) of the PDB; and plug the three power cables of the UPS 1 into the connectors (❹), (❺) and (❻) of the PDB.

Step 2

Use the PDB communication cable and parallel cables (Ⓐ), (Ⓑ) and (Ⓒ) to connect the parallel ports of the PDB and the UPS. We recommend Daisy Chain connection*¹.



NOTE:

*¹ The PDB communication cable is provided in the PDB's package and the parallel cables are provided in each UPS's package.

Chapter 8 : External Battery Pack

8.1 External Battery Pack Options

The UPS does not have internal batteries and must be connected to the external battery pack(s); see the options below.

1. Standard battery pack–Delta lead-acid battery pack (optional)

Each RT-15K3P/ RT-20K3P UPS needs to be connected to two Delta lead-acid battery packs*¹. Each RT-10K3P UPS needs to be connected to one Delta lead-acid battery pack.

You can parallel several battery packs to increase the back-up time. The number of the battery packs for RT-15K3P/ RT-20K3P UPS must be a multiple of two; for instance, if you parallel two RT-15K3P/ RT-20K3P UPSs, you should connect four Delta lead-acid battery packs*¹.

For more information, please refer to **Chapter 8.5**.



NOTE:

*¹ This is not applicable to the parallel UPSs with the common battery application. For more information about common battery, please refer to **Chapter 7.4.3** or contact Delta customer service.

2. Standard battery pack–Delta lithium-ion battery pack (optional)

For RT-15K3P and RT-20K3P UPS, please use RT-20K-LIB.

For RT-10K3P UPS, please use RT-10K-LIB.

Each UPS must connect to only one Delta lithium-ion battery pack. You cannot connect more than one to the UPS; for instance, if you parallel two UPSs, neither more nor less than two Delta lithium-ion battery packs are to be connected. For more information, please refer to **Chapter 8.5**.

3. Customer-owned pack–lead-acid battery or others

Alternatively, you may use your own batteries. The number of lead-acid batteries should meet the requirements in **Table 8-1-1/ Table 8-1-2**. Note that after the battery connection, you have to complete the settings in the **Initial Setting Screen** following the instructions in **Chapter 8.5.2**. The settings can be adjusted later in the **Setting Menu's** Battery screen (refer to **Chapter 10.2.2**). Please contact service personnel if you need more information.

Table 8-1-1: Battery Parameters_ Customer-Owned Lead-acid Batteries_ for RT-10K3P

Battery Q'ty	Battery Type	Float Charging Voltage* ²	Charging Current* ³
22 PCS × 1	Lead-acid	299.6V ± 1%	At 25°C (77°F) 1.5A (default)
21 PCS × 1		286.0V ± 1%	
20 PCS × 1		272.4V ± 1%	
19 PCS × 1		258.7V ± 1%	
18 PCS × 1		245.1V ± 1%	
17 PCS × 1		231.5V ± 1%	
16 PCS × 1		217.9V ± 1%	
12 PCS × 1* ¹		163.4V ± 1%	

Table 8-1-2: Battery Parameters_ Customer-Owned Lead-acid Batteries_ for RT-15K3P & RT-20K3P UPS

Battery Q'ty	Battery Type	Float Charging Voltage* ²	Charging Current* ³
22 PCS × 2	Lead-acid	229.6V ± 1%	At 25°C (77°F) 1.5A (default)
21 PCS × 2		286.0V ± 1%	
20 PCS × 2		272.4V ± 1%	
19 PCS × 2		258.7V ± 1%	
18 PCS × 2		245.1V ± 1%	
17 PCS × 2		231.5V ± 1%	
16 PCS × 2		217.9V ± 1%	
12 PCS × 2* ¹		163.4V ± 1%	



NOTE:

1. *1 When the UPS connects to 12 PCS × 2 batteries, the rated output power of the UPS needs to be de-rated to 70%.
2. *2 These are default values.
3. *3 For the customer-owned lead-acid batteries, the maximum settable charging current is 8A. The charging current will be influenced by on-site configurations, environment temperature and load conditions. If you need to modify the default charging current, please contact your local dealer or Delta customer service.
4. You can turn on or turn off boost charging via the LCD. Go to  → **Charger** → **Execute Boost Charge** → **No/ Yes**.

8.2 Installation of the External Battery Pack

The Delta standard battery pack can be rack-mounted or tower-mounted with the UPS; their mounting kits and installation procedures are identical to the UPS's. For details, please refer to **Chapter 6.1 ~ Chapter 6.2**.

For installation of customer-owned battery pack, please contact service personnel.

8.3 External Battery Pack Connection Warnings

- Use only the same type of batteries from the same supplier. Never use old, new and different Ah batteries at the same time.
- The number of batteries must meet the UPS's requirements.
- Do not connect the batteries in reverse.
- After connecting the Delta lead-acid battery packs (optional) or the customer-owned lead-acid battery packs to the UPS, use a voltage meter to measure whether the total voltage is around $12.5\text{Vdc} \times$ the total number of batteries.

8.4 Battery Overcurrent Protection Device

1. A Delta standard battery pack has a built-in overcurrent protection device.
2. For connection to the customer-owned batteries, it is required to install an appropriate DC breaker or fast-acting fuses that meets the safety certifications. Please refer to **Table 7-3** for the recommended battery breaker capacity. Do not use an AC breaker. Besides, the breaker must be a 2-pole DC breaker with 1-pole 250Vdc, 2-pole 500Vdc, and 10kA (or above) DC breaking capacity.

8.5 Delta Standard Battery Pack (Optional)

When connecting the Delta standard battery pack to the UPS, please also refer to the *User Manual* included in the package of the battery pack.

Table 8-2: Battery Parameters_ Delta Standard Battery Pack

Battery Type	Float Charging Voltage	Charging Current* ³	Low Battery Shutdown	Battery Q'ty (Per Batt. Pack)
Delta lead-acid battery pack (RT-10KB)* ¹	272.4V ± 1% at 25°C (77°F)	1.5A (default)	1. 216V ± 2V (when the back-up time > 1 hour or the loads < 30%) 2. 210V ± 2V (when the back-up time < 1 hour)	12V × 20 PCS
Delta lithium-ion battery pack (RT-20K-LIB/ RT-10K-LIB)* ²	216V ± 2V	1.5A (default)	162V ± 2V	189V × 2 PCS



NOTE:

- *¹ You can connect several paralleled battery packs to the UPS to increase the back-up time. The number of the battery packs for RT-15K3P/ RT-20K3P UPS must be a multiple of two.
- *² RT-20K-LIB is applicable to RT-15K3P and RT-20K3P UPS; RT-10K-LIB is applicable to RT-10K3P UPS. Each UPS must connect to only one Delta lithium-ion battery pack. More than one is not permitted.
- *³ For the Delta lead-acid battery pack, the maximum settable charging current is 8A. For the Delta lithium-ion battery pack, the maximum settable charging current is 6A. For the setting information, refer to **Chapter 10.2.2**. The charging current will be influenced by on-site configurations, environment temperature and load conditions. If you need to modify the default charging current, please contact your local dealer or Delta customer service.

8.5.1 Connection to Delta Standard Battery Pack



NOTE:

1. Please read this chapter and **Chapter 7.1** thoroughly before making any connection.
2. Before connecting the Delta lead-acid battery pack to the UPS, please check if the rated voltage of the battery pack is suitable for the UPS.
3. The rear panel changing for RT-10K3P, RT-15K3P and RT-20K3P UPSs is the same. Take RT15/ 20kVA UPS as an example.

There are two options below.

1. Delta lead-acid battery pack (3U in height)
2. Delta lithium-ion battery pack (2U in height)

Before connecting the standard battery pack, please make sure to adopt the suitable UPS rear panel. The original rear panel fixed on the UPS in the factory is for Delta lead-acid battery pack. If using the Delta lithium-ion battery pack, you have to replace the original UPS rear panel with the UPS rear panel provided in the package of the Delta lithium-ion battery pack. The replacement procedures are shown in the following figures (1) ~ (4).

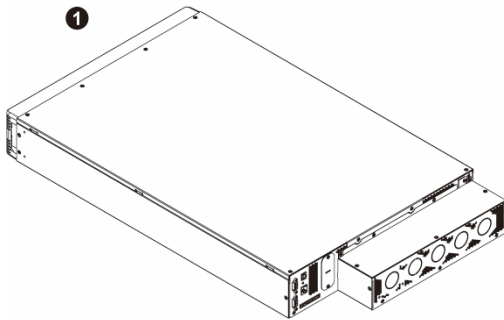

(Rear view of the UPS: with the original rear panel for Delta lead-acid battery pack.)

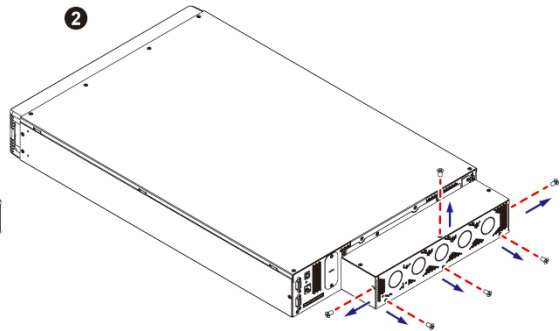

(Remove the original UPS's rear panel.)

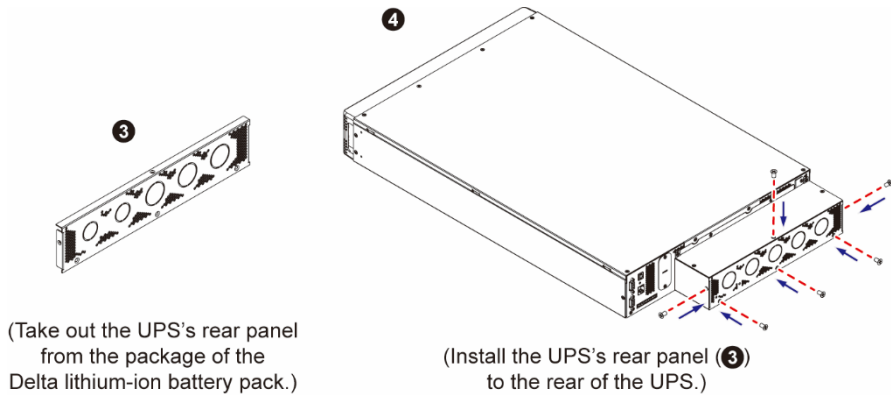

8.5.1.1 Connection to the Delta Lead-acid Battery Pack (Height 3U, Optional) for RT-10K3P UPS

Please follow the instruction below and reference the Delta lead-acid battery pack's User Manual to perform battery connection.

To connect the Delta lead-acid battery pack, plug the battery cable into the battery connector and use the screws and standoffs to firmly fix the battery cable. The battery cable, screws and standoffs are provided in the package of the battery pack.

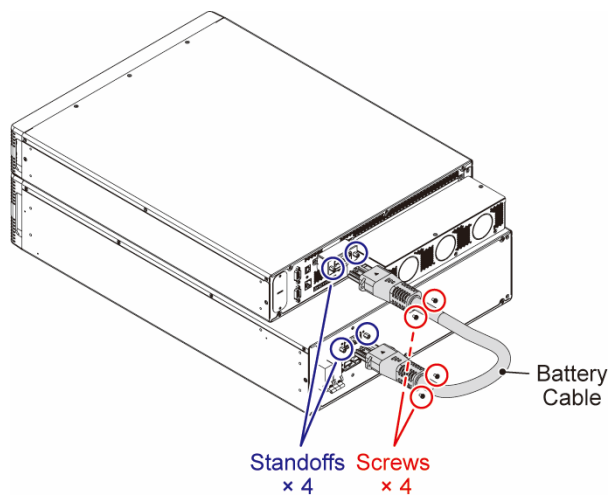

(Figure 8-1: Connect the RT-10K3P UPS with the Delta Lead-acid Battery Pack)

8.5.1.2 Connection to the Delta Lithium-ion Battery Pack (Height 2U, Optional) for RT-10K3P UPS

Please follow the instruction below and refer to the Delta lithium-ion battery pack's *User Manual* to perform battery connection.

To connect the Delta lithium-ion battery pack, plug the battery cable into the battery connector, and use the screws and standoffs to firmly fix the battery cable. Then, use the RS-485 cable*¹ to connect the UPS and the battery pack.

The battery cable, screws, standoffs and the RS-485 cable are provided in the package of the battery pack.

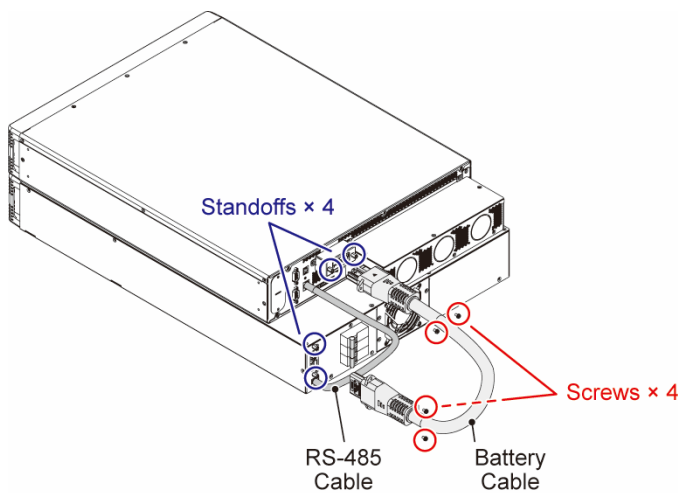

(Figure 8-2: Connect the RT-10K3P UPS with the Delta Lithium-ion Battery Pack)

8.5.1.3 Connection to the Delta Lead-acid Battery Pack (Height 3U, Optional) for RT-15K3P and RT-20K3P UPS

For connection to the Delta lead-acid battery pack, the battery cables and cable glands are installed on the UPS before the UPS is shipped*¹, as shown in *Figure 8-3*.

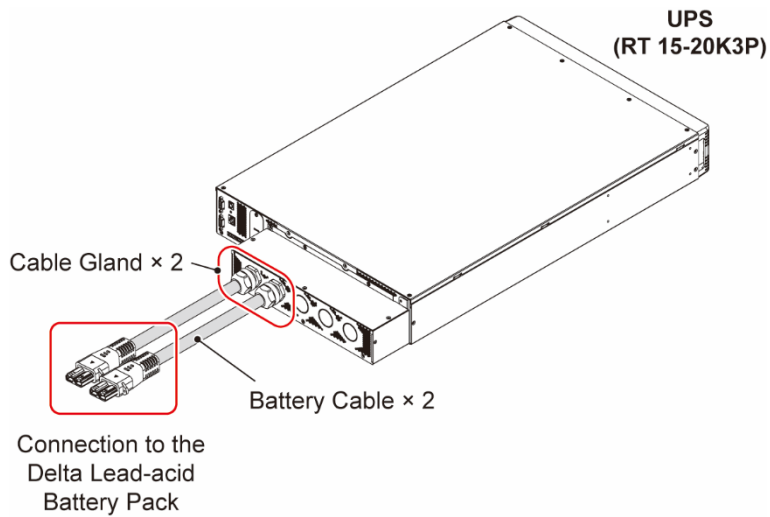

(Figure 8-3: Battery Cables and Cable Glands Installed before Shipment)



NOTE:

*1 This depends on different UPS model requirements. Please refer to below for more information.

As the Delta lead-acid battery pack is optional, if the UPS model purchased by users does not have battery cables and cable glands installed on the UPS before shipment, the two battery cables*1 will need to be connected to the UPS's wiring terminals (including the battery input terminals and grounding terminal (\perp)) according to the instructions of the Delta lead-acid battery pack's **User Manual**. For details about the UPS's wiring terminals, please refer to **Chapter 7.3**. Note that the connection should be performed by qualified service personnel.



NOTE:

*1 The battery cables are provided in the UPS's package but users should prepare the cable glands.

After connection to the UPS's wiring terminals, please follow the instruction below and refer to the Delta lead-acid battery pack's **User Manual** to perform the battery connection.

For each Delta lead-acid battery pack, plug the battery cable into the connector. Use two screws and two standoffs to firmly fix the battery cable.

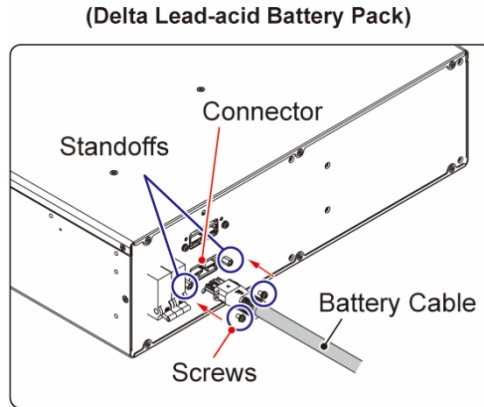

(Figure 8-4: Connect the UPS with the Delta Lead-acid Battery Pack)

8.5.1.4 Connection to the Delta Lithium-ion Battery Pack (Height 2U, Optional)

For connection to the Delta lithium-ion battery pack, the battery cable and cable glands are installed on the UPS before the UPS is shipped*1, as shown in **Figure 8-5**.

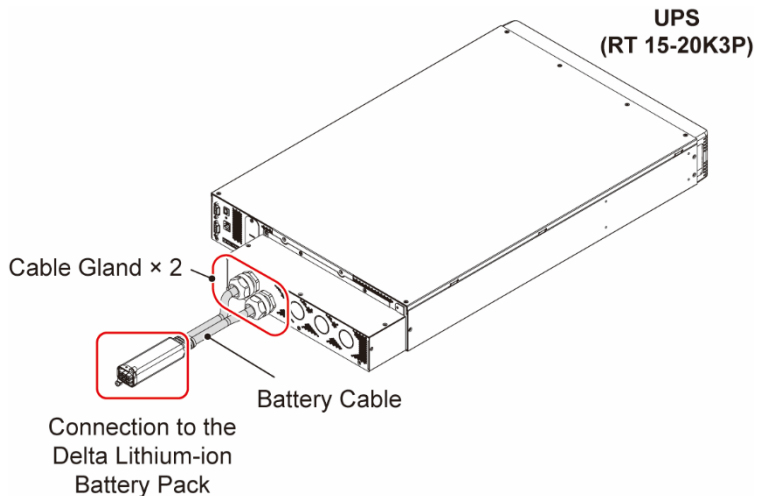

(Figure 8-5: Battery Cable and Cable Glands Installed before Shipment)



NOTE:

*1 This depends on different UPS model requirements. Please refer to below for more information.

As the Delta lithium-ion battery pack is optional, if the UPS model purchased by users does not have battery cable and cable glands installed on the UPS before shipment, the battery cable*¹ will need to be connected to the UPS's wiring terminals (including the battery input terminals and grounding terminal (\ominus)) according to the instructions of the Delta lithium-ion battery pack's **User Manual**. For details about the UPS's wiring terminals, please refer to **Chapter 7.3**. Note that the connection should be performed by qualified service personnel.



NOTE:

*¹ The battery cable is provided in the package of the Delta lithium-ion battery pack but users should prepare the cable glands.

After connection to the UPS's wiring terminals, please follow the instruction below and reference the Delta lithium-ion battery pack's **User Manual** to perform the battery connection.

Plug the battery cable into the Delta lithium-ion battery pack's connector, and use the RS-485 cable to connect the UPS and the battery pack. The RS-485 cable is provided in the package of the Delta lithium-ion battery pack.

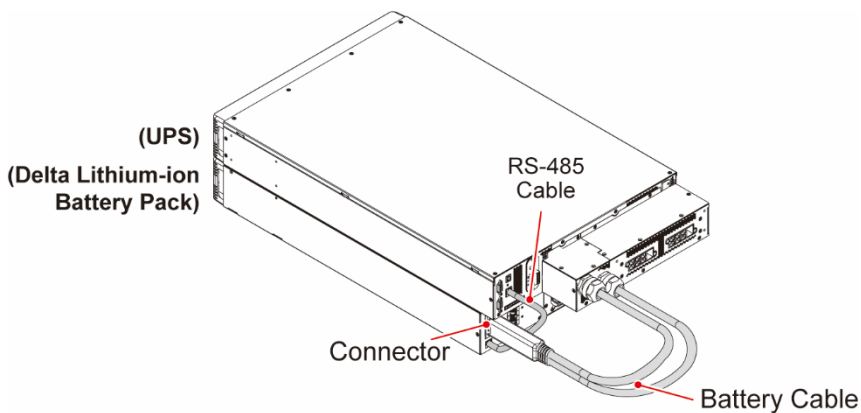

(Figure 8-6: Connect the UPS with the Delta Lithium-ion Battery Pack)

8.5.2 Battery Setup (Initial Setting Screen) & Battery Selection Notice

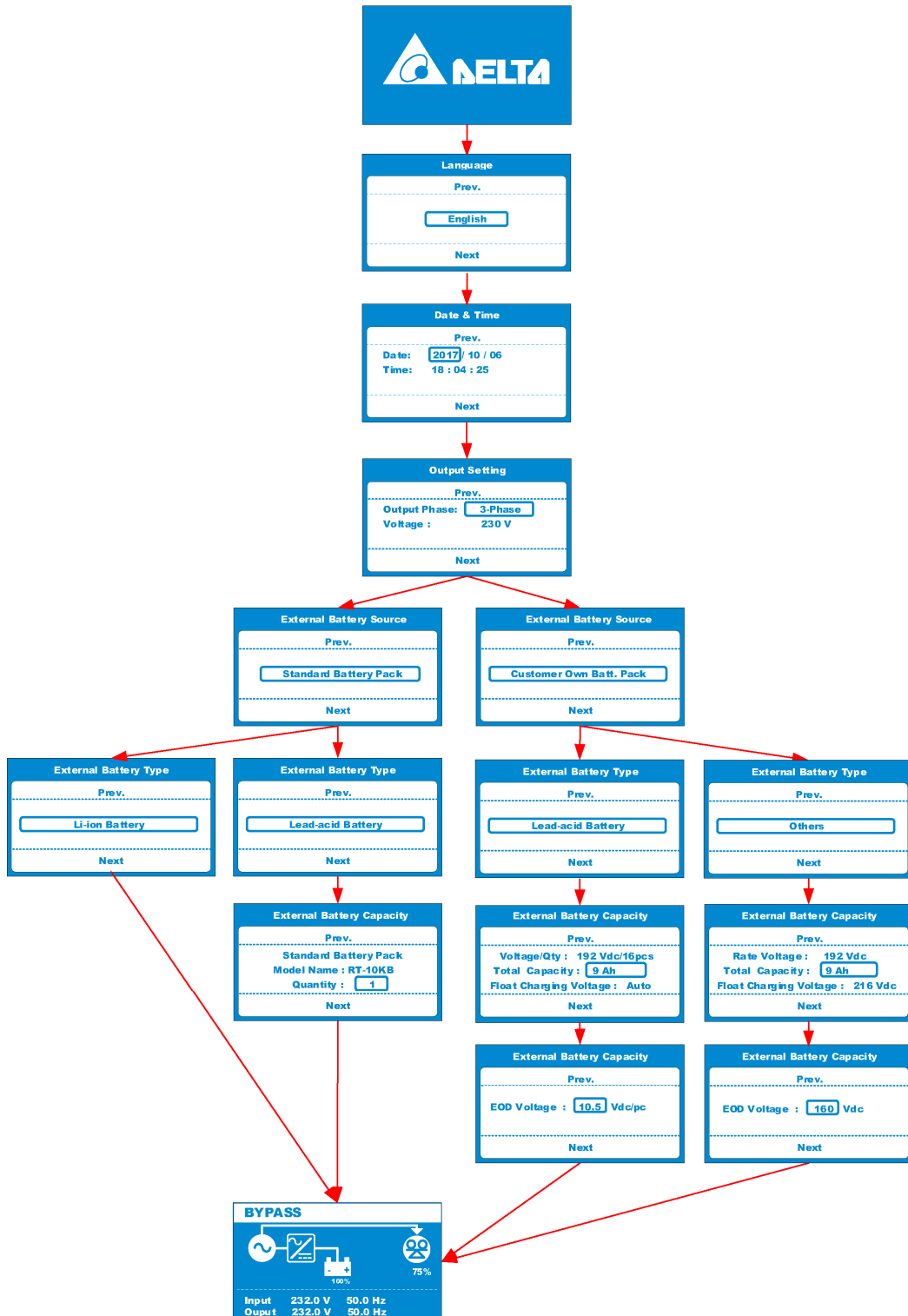

8.5.2.1 Battery Setup (Initial Setting Screen)

Follow the instructions of the figure above and the content below to complete the battery setup in the **Initial Setting Screen**. The options of the external battery source and type are as below.

- Standard battery pack: (A) lead-acid battery (B) lithium-ion battery
- Customer-owned battery pack: (C) lead-acid battery (D) others

(A) Delta lead-acid battery pack (optional)_ initial setting procedures

1. After entering the **Initial Setting Screen**, set up Language.
2. Set up Date & Time.
3. Set the rated output voltage.
4. Set the External Battery Source as '**Standard Battery Pack**'.
5. Set the External Battery Type as '**Lead-acid Battery**'.
6. Set up '**Model Name**' and '**Quantity**'.
7. After you finish all the initial settings, the LCD will enter the Main Screen.

(B) Delta lithium-ion battery pack (optional)_ initial setting procedures

1. After entering the **Initial Setting Screen**, set up Language.
2. Set up Date & Time.
3. Set up the rated output voltage.
4. Set the External Battery Source as '**Standard Battery Pack**'.
5. Set the External Battery Type as '**Li-ion Battery**'.
6. After you finish all the initial settings, the LCD will enter the Main Screen.

(C) Customer-owned battery pack (lead-acid battery)_ initial setting procedures

1. After entering the **Initial Setting Screen**, set up Language.
2. Set up Date & Time.
3. Set up the rated output voltage.
4. Set the External Battery Source as '**Customer Own Batt. Pack**'.
5. Set the External Battery Type as '**Lead-acid Battery**'.
6. Set up '**Voltage/Qty**' and '**Total Capacity**'.
7. Set up '**EOD Voltage**'
8. After you finish all the initial settings, the LCD will enter the Main Screen.

(D) Customer-owned battery pack (others)_ initial setting procedures

1. After entering the **Initial Setting Screen**, set up Language.
2. Set up Date & Time.
3. Set up the rated output voltage.
4. Set the External Battery Source as '**Customer Own Batt. Pack**'.
5. Set the External Battery Type as '**Others**'.
6. Set up '**Rated Voltage**', '**Total Capacity**' and '**Float Charging Voltage**'.
7. Set up '**EOD Voltage**'
8. After you finish all the initial settings, the LCD will enter the Main Screen.

8.5.2.2 Battery Selection Notice

The specifications of the customer-owned battery pack must comply with the following conditions. You should be aware of the notes and precautions below.



WARNING:

If the batteries do not meet the following specifications or users do not make correct settings of the charging voltage, capacity, EOD voltage, etc., it may cause damage to the UPS and the batteries, or lead to industrial safety problems. The warranty does not cover damage or loss caused by inappropriate use of the product. If you have any problem in purchasing the batteries, please contact Delta service personnel.

● **Customer Own Batt. Pack - Lead-acid battery**

1. Appropriate battery capacity (Ah)

5, 7, 9, 12, 15, 24, 33, 38, 40, 50, 65, 80, 100, 120, 150, 200 Ah

Note that the maximum charging current is 8A. Using batteries with larger capacity will lead to longer charging time.

2. Appropriate battery voltage range

+/- 12 PCS, +/- 16 ~ 22 PCS

(12 PCS or 16 ~ 22 PCS per string, at least two strings for each UPS)

3. Appropriate float charging voltage

Float charging voltage is 'Auto' (2.27 Vdc/cell) by default.

Settable range 2.23 ~ 2.3 Vdc/cell (0.01 Vdc/cell per step), a typical 12V lead-acid battery pack contains 6 battery cells.

4. Appropriate EOD voltage

10.5 ~ 11 Vdc/PC

- **Customer Own Batt. Pack – Others**

You may use another type of batteries, for example, ternary lithium battery, lithium iron phosphate battery, etc. If you are not sure about the battery type and whether the batteries are applicable to the UPS, please contact Delta service personnel.

1. **Appropriate battery voltage range**

144 ~ 312 Vdc

2. **Appropriate float charging voltage**

150 ~ 310 Vdc

3. **Appropriate EOD voltage**

114 ~ 242 Vdc

8.5.2.3 Precautions for External Battery Pack

1. When connecting the UPS to an external battery pack mentioned above or any other battery pack with a management system, please beware of the insulation resistance between the positive terminal (+)/ negative terminal (-) and the PE chassis. Note that low insulation resistance or low impedance circuit owing to insulation breakdown will lead to operation errors or abnormalities of the UPS. The battery circuit's insulation resistance to ground should exceed 2 MΩ. If there is no such specification for reference, we recommend conducting a high voltage insulation test between the positive terminal (+)/ negative terminal (-) and the PE chassis of the entire battery system with a hipot tester.

Test condition: 2820 Vdc/60s. Acceptance condition: < 1 mA.

2. Before changing the battery settings, please transfer to bypass mode and remove the battery connection (both power and signal cables) first. Wait until you see 'Battery Disconnected' shown on the LCD before you change the battery settings. After that, connect the batteries (both power and signal cables) and turn on the UPS inverter.
3. For lead-acid batteries, the UPS will switch between boost charging mode and float charging mode automatically. For other batteries, only float charging mode is available.
4. Common battery is applicable to parallel UPSs, however, not applicable to parallel UPSs connecting to lithium-ion batteries.
5. To use a ground detection voltmeter with the UPS, please contact Delta service personnel.



WARNING:

Some ground detection voltmeters can impact the UPS operation or even damage it.

6. For the Delta lithium-ion battery pack, no need to set up the parameters.

8.5.3 Battery Replacement (Standard Battery Pack)



WARNING:

1. Only qualified service personnel can perform battery replacement. Before battery replacement, please turn off the battery breaker and remove the communication cable. Please wait for five minutes and make sure the UPS has detected “Battery Disconnected”, and then you can replace batteries. After that, you can turn on the battery breaker and connect the communication cable (only the UPS connecting to a lithium-ion battery pack uses a communication cable).
2. A battery can present a risk of electrical shock and high short-circuit current due to improper operation. Keep unauthorized personnel away from the batteries and battery packs.
3. Servicing of batteries and battery packs should be performed or supervised by qualified service personnel knowledgeable in batteries, battery packs and the required precautions.
4. For lead-acid batteries, use only the same type of batteries from the same supplier. Never use old, new and different Ah batteries at the same time.
5. The following precautions should be observed before battery replacement:
 - Remove watches, rings, or any other metal objects.
 - Use tools with insulated handles.
 - Wear rubber gloves and boots.
 - Do not lay tools or metal parts on the top of batteries.
 - Disconnect charging source prior to connecting or disconnecting the battery input terminals.
 - Remove every battery grounding during installation and maintenance to reduce the likelihood of electric shock. If any part of the batteries is grounded, please remove the grounding connection.
6. Please read the **Battery Precautions** section thoroughly in **Chapter 1** before replacing the batteries.

Please refer to the instructions below to replace the battery module of the Delta standard battery pack (optional). The battery replacement procedures for the models RT-10K3P, RT-15K3P and RT-20K3P are the same. Take RT 15/20kVA UPS as an example.

1. Battery Replacement Procedures_ Delta Lead-acid Battery Pack (Optional)

- (1) Remove the screws and the battery pack's front panel.
- (2) Disconnect the battery input terminals.
- (3) Use a Phillips screwdriver to remove the screws on the protection cover in front of the battery module. Then, remove the protection cover.
- (4) Extract the battery module from the compartment and replace it with a new one.



NOTE:

Moving the battery module (weight: 28 ± 1 kg (61.7 ± 2.2 lbs)) requires two people.

To reassemble the battery pack, please perform the steps (1) ~ (4) above in reverse sequence.

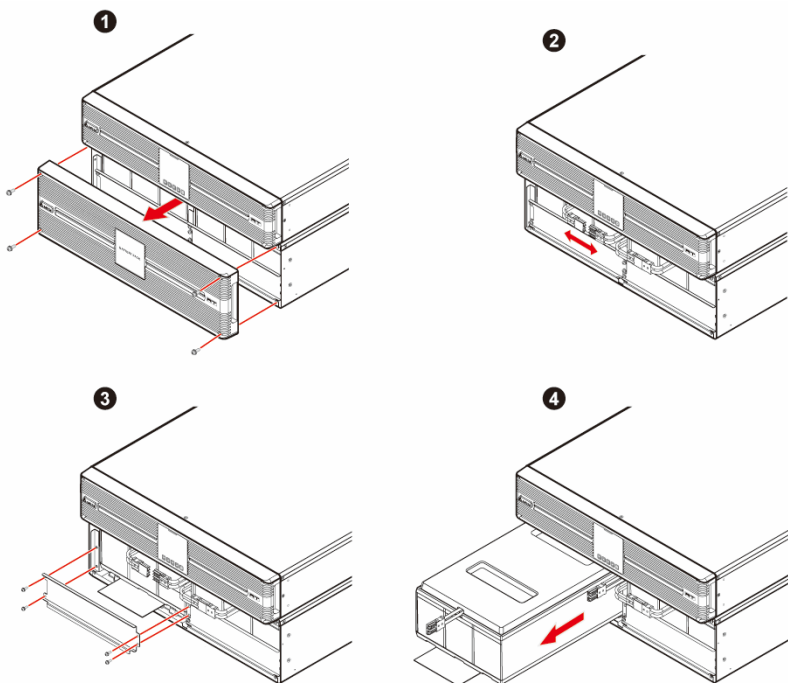

2. Battery Replacement Procedures_ Delta Lithium-ion Battery Pack (Optional)

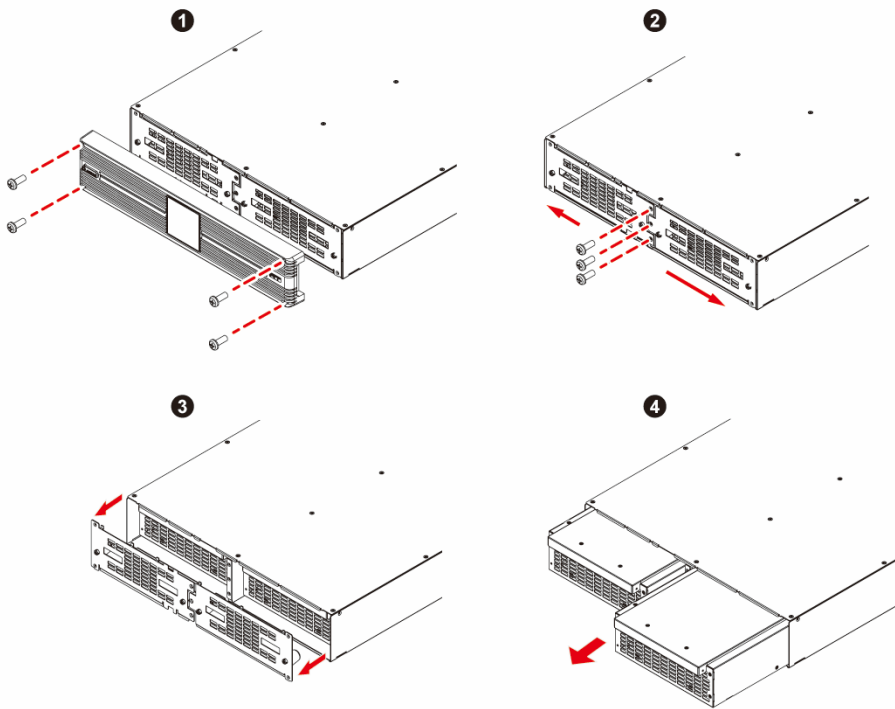

- (1) Remove the screws and the battery pack's front panel.
- (2) Use a Phillips screwdriver to remove the screws on the protection cover in front of the battery module.
- (3) Remove the protection cover.
- (4) Extract the battery module from the compartment and replace it with a new one.

To reassemble the battery pack, please perform the steps (1) ~ (4) above in reverse sequence.



8.6 UPS's Battery Alarm

- When an external battery pack connected to the UPS has problems, the UPS will sound an alarm. For more information, please refer to **Chapter 9.3**.
- After you reconnect or replace the batteries, it might take a while for the UPS to switch off the alarm automatically. If the audible alarm still exists after a period of time, please manually initiate a battery test. Please follow the route below to execute the manual battery test in order to clear the alarm.

Press the Enter button () for 0.1 second → select the icon () → select **Test** → select **Start Battery Test**. For details, please refer to **Chapter 10.2.4**.

Chapter 9 : Operation

9.1 Start-up Procedures



NOTE:

If the UPS is connected to an inductive load, the inrush current (initial surge current) may cause the inverter to restart when you power on the UPS. To avoid this situation, please power on the UPS in bypass mode.



9.1.1 AC mode Start-up

Once the main input and bypass input supply power to the UPS via the breaker(s)/ protection device(s), the auxiliary power will start functioning automatically. If the UPS is powered on for the first time with the AC input*¹, the UPS will go to the initial setting mode. Please refer to **Chapter 8.5.2** and **Chapter 10.1** to perform initial settings. After that, the UPS will transfer to standby or bypass mode.





NOTE:

*¹ When you power on the UPS with AC input for the first time, please make sure both the main input and bypass input can supply power normally.

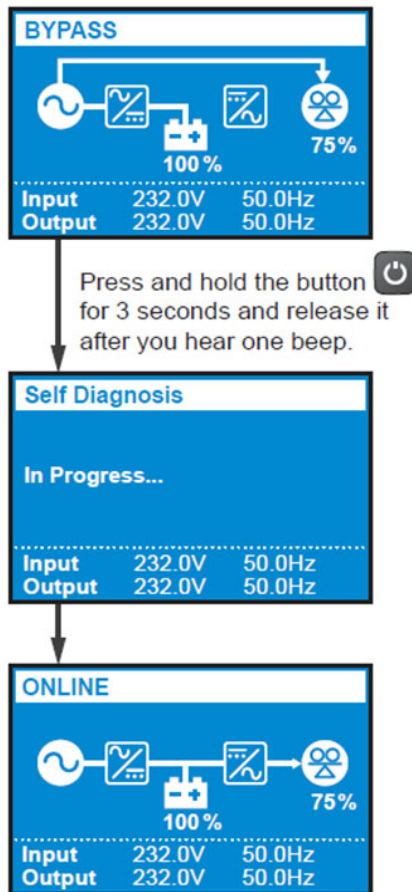
In standby or bypass mode, press and hold the ON/ OFF button () for 3 seconds, and the buzzer will be on in the following 2 seconds. If the ON/ OFF button () is released within 2 seconds, the UPS will depend on its setting to run in online, ECO or frequency conversion mode. Otherwise, the UPS will stay in standby or bypass mode.



9.1.2 Cold Start

When there is no AC input and you have connected the external batteries^{*1} to the UPS, press and hold the ON/ OFF button () for 3 seconds, and the buzzer will be on in the following 2 seconds. If the ON/ OFF button () is released within 2 seconds, the UPS will start up in battery mode. Otherwise, the UPS will remain off.

Before cold start, the UPS should be turned on with the AC input^{*2} first to save the frequency of the AC input. After that, the UPS will be able to perform cold start according to the frequency saved. If there is no frequency data, the UPS cannot perform cold start.



NOTE:

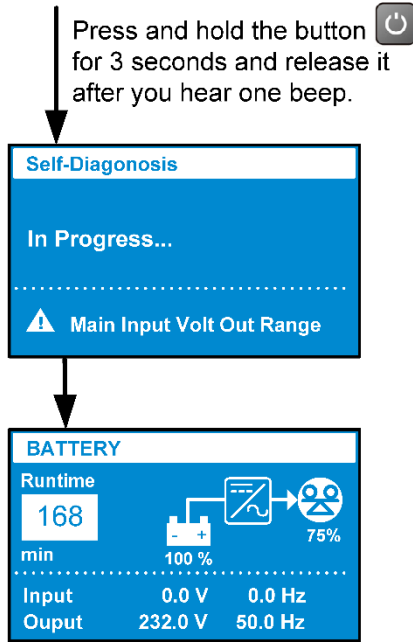

- ^{*1} Cold start is not available when you use lithium-ion batteries.
- ^{*2} When you power on the UPS with AC input for the first time, please make sure both the main input and bypass input can supply power normally.

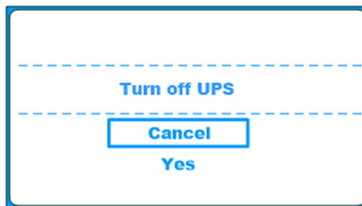

9.2 Shutdown Procedures

In online mode or battery mode, press and hold the ON/ OFF button () for 3 seconds and release it after you hear the beep sound. Then, the LCD will show the confirmation page as below.



Press the Scrolling Up or Down (/) button to select 'Yes' and press the Enter button ().

After that, the inverter will be off, and the UPS will transfer to run in standby or bypass mode.

When the main AC input is still available, the UPS will keep charging the batteries even when it is in standby or bypass mode. To turn off the UPS completely, please unplug the input power cables or turn off all the input breakers. Only when there is no main input and bypass input power will the UPS be completely off.

9.3 Alarm & Silence Function

When a fault condition occurs, there will be an alarm message shown on the LCD and audible warning from the buzzer. Please see the table below for details.

No.	UPS Status	Alarm
1	Battery Mode	The buzzer sounds once every 2 seconds.
2	Battery Low Warning	The buzzer sounds once every 0.5 second.
3	Battery Missing/ Weak Battery/ Battery Replacement	The buzzer sounds once every 2 seconds.
4	UPS Overload	1. Overload_ 105% ~ 125%: The buzzer sounds once every 2 seconds. 2. Overload_ 125% ~ 150%: The buzzer sounds once every 0.5 second.
5	UPS Internal Fault	The buzzer sounds continuously for 5 seconds when the UPS detects an internal fault. After the 5-second long beep, the buzzer sounds once every 2 seconds.

Press and hold the Escape button () for 3 seconds to clear the audible warning; however, the alarm message will still be on the screen.

For example, if the UPS detects 'Battery Disconnected', it will show the event code and alarm message as below.

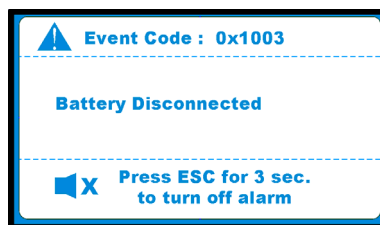

After 5 seconds, the LCD display will go back to the main screen automatically but the event code and alarm message will still appear alternately every 5 seconds at the bottom of the main screen unless the fault condition is cleared.

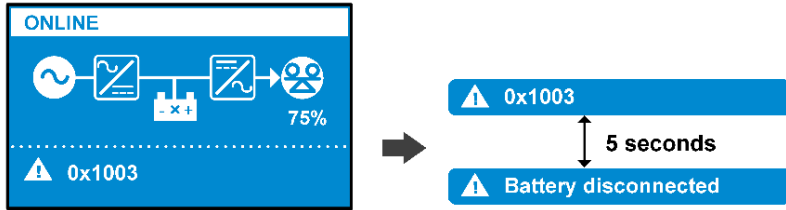

Please refer to **Chapter 12** for all the event codes and alarm messages and the corresponding solutions.

9.4 Operation Modes

This chapter gives detailed information about the UPS operation modes, including initial setup mode and normal operation modes. For the main screen of each mode, refer to **Chapter 3.3.2**.

- **Initial Setting Mode**

If the UPS is powered on by the AC input for the first time, the UPS will go to the **Initial Setting Screen** to guide users to set up important parameters. Please refer to **Chapter 8.5.2** and **Chapter 10.1**. The **Initial Setting Screen** will not appear again once you finish the initial settings. The next time that the UPS is powered on, it will directly go to the **DELTA Welcome Page** and enter the **Main Screen**.

- **Standby Mode**

When (1) the UPS is only powered on by the AC input or batteries without pressing the ON/ OFF button (🔌) and (2) the bypass output is disabled, the UPS output will be off, and the charger will start to charge the batteries while the AC input is within the acceptable range.

- **Bypass Mode**

When (1) the UPS is only powered on by the AC input or batteries without pressing the ON/ OFF button (🔌) and (2) the bypass output is enabled, the UPS output will be on and the charger will start to charge the batteries while the AC input is within the acceptable range.

- **Online Mode**

When the AC input is within the acceptable range and you press the ON/OFF button () to turn on the UPS, the UPS will operate in online mode and supply stable output to the loads through the main input, AC-DC (PFC) and DC-AC (inverter) circuit.

- **Battery Mode**

When (1) there is no AC input and you press the ON/OFF button () to turn on the UPS*¹ or (2) the UPS runs in online mode and detects that the AC input is out of the acceptable range, the UPS will operate in battery mode and supply stable output to the loads through the battery, AC-DC (PFC) and DC-AC (inverter) circuit.



NOTE:

*¹ Please refer to **Chapter 9.1.2** for details. The cold start function is not available when you use lithium-ion batteries.

- **ECO Mode**

After powered on, the UPS will supply power through the inverter first, and then transfer to bypass if the bypass source is within the acceptable range. Once the bypass source is out of the acceptable range, UPS will transfer back to the inverter immediately to keep the output voltage and frequency within the acceptable range. Note that ECO mode is only applicable to single UPS but not to parallel UPSs.

- **Frequency Conversion Mode**

In this operation mode, the loads are always fed by the inverter. The output frequency is fixed at 50 Hz or 60 Hz depending on the output frequency setting.

The bypass path is disabled during this operation mode because the inverter is not tracking the bypass input frequency. Note that frequency conversion mode is only applicable to single UPS but not to parallel UPSs.

Chapter 10 : LCD Display & Settings



NOTE:

1. Please refer to **Chapter 3: Operation Panel** to learn how to operate the operation panel and understand every icon/ diagram definition.
2. Each of the display diagrams shown in this chapter is for reference only. The actual display depends on the operation of the UPS. The following flow charts will help you understand how to navigate the display screens.

10.1 Initial Setting Screen

When the UPS is powered on for the first time with the AC input, the LCD display will enter the **Initial Setting Screen**, and you can modify the settings of Language, Date & Time, Output Setting (Output Phase/ Voltage/ Frequency), External Battery Source, External Battery Type and External Battery Capacity based on your needs and actual conditions. Please refer to **Chapter 8.5.2** for details about the initial settings.

The default settings may vary according to different models. Press the Scrolling Down button () to continue if no change is needed. After initial settings, the LCD display will move to the **Main Screen** that shows the current operation mode.

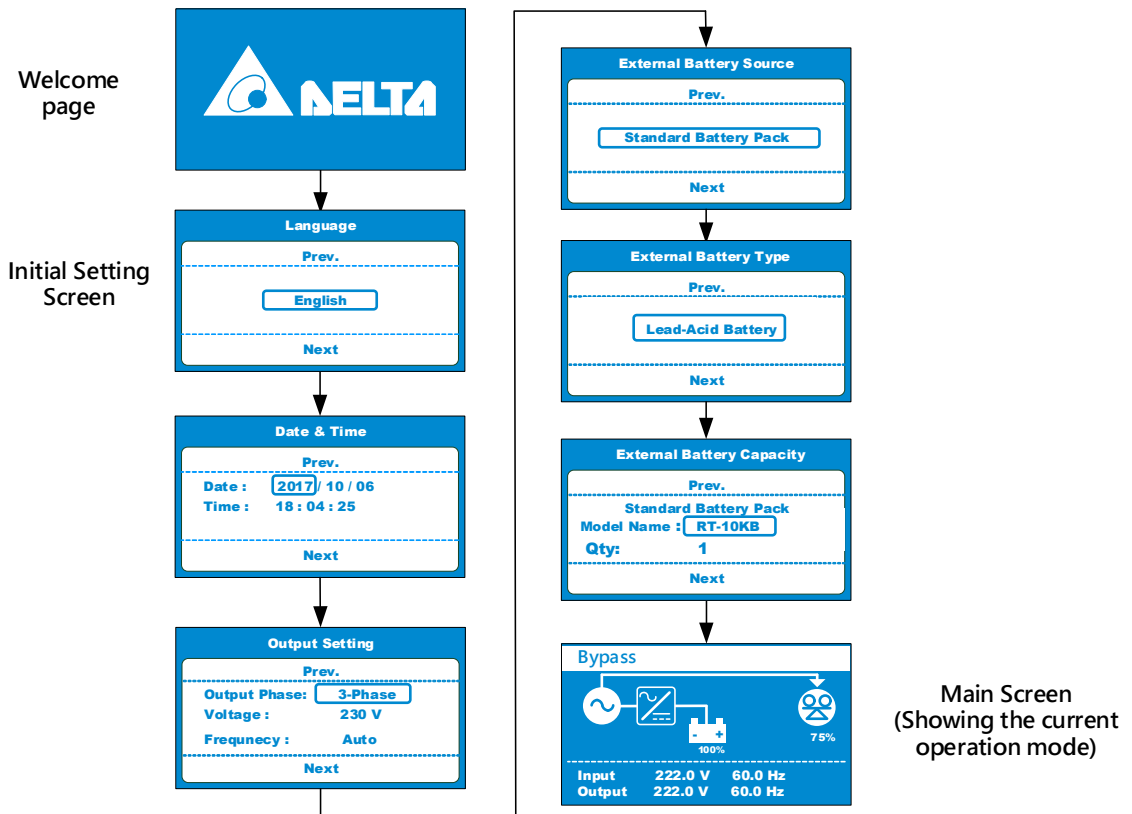

The **Initial Setting Screen** will no longer appear after you complete the initial settings. The next time that the UPS is powered on, the LCD display will show the **DELTA Welcome Page** for 3 seconds and then directly go to the **Main Screen** that shows the current operation mode.

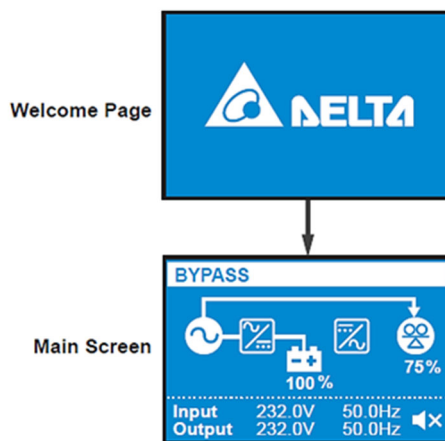

10.2 Main Menu



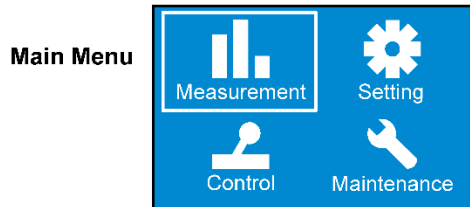







In the **Main Screen**, press the Enter button () for 0.1 second to enter the **Main Menu** where you can view or set up relevant items.



NOTE:

Please note that only qualified service personnel can perform the setup.

For setup procedures, please refer to the following:

1. In the **Main Menu**, select the item you want to configure and press the Enter button () for 0.1 second. After that, the UPS will enter the setting mode.
2. Press the Scrolling Up or Down button ( / ) for 0.1 second to navigate the setting items.
3. Press the Enter button () for 0.1 second to choose the parameter that you want to change, and the parameter will flash.
4. Press the Scrolling Up or Down button ( / ) for 0.1 second to increase or decrease the parameter value. If either of the buttons is pressed for over 2 seconds, the LCD will automatically increase or decrease by the selectable value every 0.2 second until the button is released or the parameter reaches its highest or lowest value.
5. Press the Enter button () to confirm your parameter setting.
6. Press the Scrolling Up or Down button ( / ) for 0.1 second to move to the previous or the next setting item.
7. If you press the ESC button (), the LCD will exit the setting mode. If you do not press any button for more than 5 minutes, the LCD will exit the setting mode and go back to the original display automatically.

Please refer to **Figure 10-1** below for all the setup items.

(Level 1)

MEASUREMENT

- (Level 2) **Output**
 - (Level 3) Vphase/ Vline
Frequency
Current/ Watts
Load/ VA
Cumulated
Power
- (Level 2) **Input**
 - (Level 3) Vphase/ Vline
Frequency
- (Level 2) **Bypass Input**
 - (Level 3) Vphase/ Vline
Frequency
- (Level 2) **Battery**
 - (Level 3) Voltage/ Capacity
Runtime
Charge Mode *1
Charge Stage
Total Capacity
Last Battery Test
Charging Current *2
Discharging Current *2
SOH *3

(Level 1)

SETUP

- (Level 2) **Output**
 - (Level 3) Output Phase
Output Voltage
Output Frequency
Output Sync. Freq. Range
Output Freq. Slew Rate
Output Mode
Standby Mode
Overload Alarm
- (Level 2) **Input**
 - (Level 3) Bypass Max. Voltage
Bypass Min. Voltage
Input Phase
- (Level 2) **ECO Mode**
 - (Level 3) ECO Mode
ECO Max. Voltage *4
ECO Min. Voltage *4
- (Level 2) **Parallel**
 - (Level 3) Redundant UPS
ID
Common Battery
- (Level 2) **On/Off Settings**
 - (Level 3) Energy Saving
Sleep Mode
Auto Restart
Auto Start on AC
- (Level 2) **Battery**
 - (Level 3) Automatic Battery Test
Deep Discharge Test
Low Battery Warning Capacity
Warning of Remaining Time
Runtime Limitation/ Charge Mode
Internal Charging Current
External Battery Source *2 *5 *6
External Battery Type *1 *2 *5 *6 *7
Model Name *5/ Qty *5
Voltage/Qty *6/ Total Capacity *6 *7
Rated Voltage *7
Float Charging Voltage
EOD Voltage/ Install Date
- (Level 2) **General**
 - (Level 3) Language/ Audible Alarm
LCD Back Light
Date/ Time
- (Level 2) **Dry Contact Setting**
 - (Level 3) Dry Contact 1 – Input
Dry Contact 2 – Output
Dry Contact 3 – Output
Dry Contact 4 – Output
Remote Control
- (Level 2) **Component Life Prediction**
 - (Level 3) Fan Life Prediction

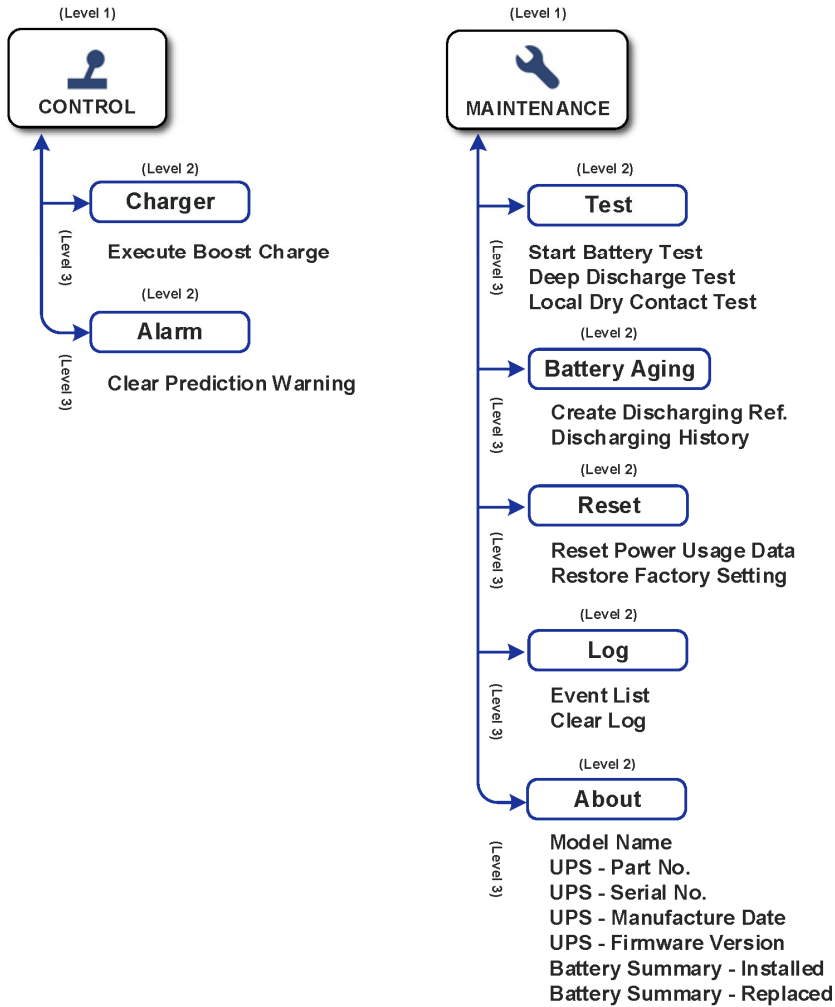

(Figure 10-1: Menu Tree)



NOTE:

- *1 The item will show up only when you select **External Battery Type** → **Lead-Acid Battery**.
- *2 If you select (1) **External Battery Source** → **Standard Battery Pack** and (2) **External Battery Type** → **Li-ion Battery**, the following items will show up.
Charging Current
Discharging Current
- *3 The item will show up only when you use specific batteries.
- *4 The item will show up only when you set the UPS operation mode as ECO mode.
- *5 If you select (1) **External Battery Source** → **Standard Battery Pack** and (2) **External Battery Type** → **Lead-Acid Battery**, the following items will show up.
Model Name
Quantity
- *6 If you select (1) **External Battery Source** → **Customer Own Batt. Pack** and (2) **External Battery Type** → **Lead-Acid Battery**, the following items will show up.
Voltage/Quantity
Total Capacity
- *7 If you select (1) **External Battery Source** → **Customer Own Batt. Pack** and (2) **External Battery Type** → **Others**, the following items will show up.
Rated Voltage

10.2.1 Measurement Menu

In the **Main Menu**, select **Measurement** () to enter the **Measurement Menu**. The **Measurement Menu** displays UPS status readings.

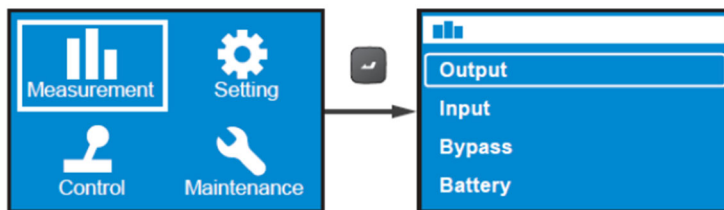

10.2.2 Setting Menu

In the **Main Menu**, select **Setting** () to enter the **Setting Menu**.

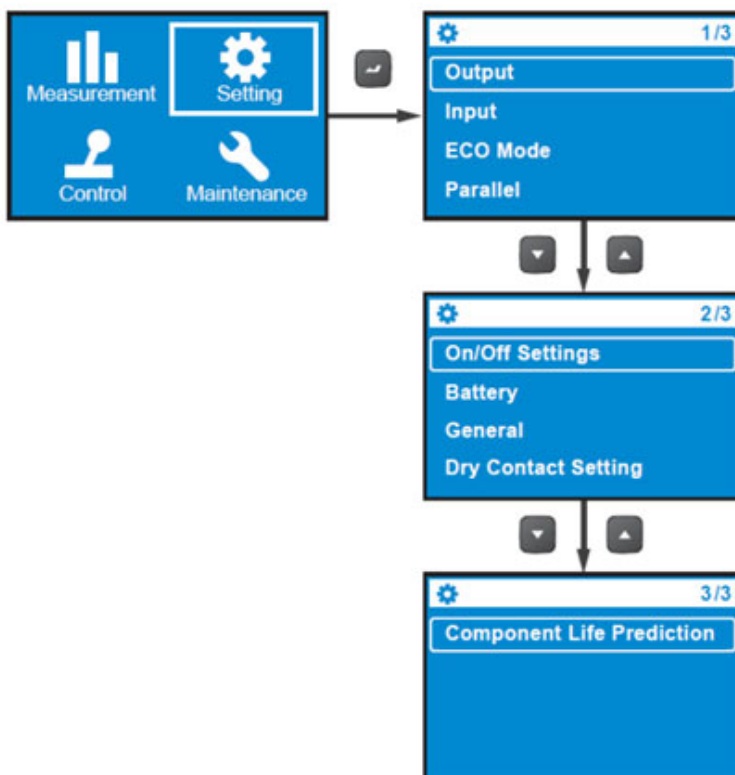

For more information about the **Setting Menu**, please refer to the tables below.

- Output

Setup Item	Options	Default
Output Phase	1-phase/ 3-phase	3-phase
Output Voltage	220V/ 230V/ 240V,	230V
Output Frequency	Auto*1/ Converter-50 Hz*2 / Converter-60 Hz*2	Auto
Output Sync. Freq. Range	± 0.5/ 1/ 3/ 5 Hz	± 3 Hz
Output Freq. Slew Rate	0.5/ 1/ 2/ 3/ 4 Hz/ Sec.	1 Hz/ sec.
Output Mode	Industrial/ IT	Industrial
Standby Mode	Bypass Output/ No Output	Bypass output
Overload Alarm	30% ~ 105% (5% per step)	105%



NOTE:

1. *1 When **Output Frequency** is set as '**Auto**', the output frequency will vary according to the bypass frequency.

If the bypass frequency is ≥ 55 Hz, **Free_Run_Frequency/ Cold_Start_Frequency** will be set as 60 Hz.

If the bypass frequency is < 55 Hz, **Free_Run_Frequency/ Cold_Start_Frequency** will be set as 50 Hz.

When **Output Frequency** is set as '**Auto**' and **Standby Mode** is set as '**Bypass Output**', the bypass output range will be the same as **Output Sync. Freq. Range**.

2. *2 When **Output Frequency** is set as '**Converter-50Hz/ Converter-60Hz**', the UPS will enter **Frequency Conversion** mode and the bypass output will be disabled.

- Input

Setup Item	Options	Default
Bypass Max. Voltage	+ 10/ 15/ 20%	+ 15%
Bypass Min. Voltage	- 10/ 15/ 20/ 25/ 30/ 35/ 40%	- 20%
Input Phase	1-phase/ 3-phase	3-phase

- **ECO Mode**

Setup Item	Options	Default
ECO Mode	Disable/ Enable	Disable
ECO Max. Voltage*1	5% ~ 15% (1% per step)	+10%
ECO Min. Voltage*1	5% ~ 15% (1% per step)	+10%



NOTE:

*1 The setup items **ECO Max. Voltage** and **ECO Min. Voltage** will only be shown on the display when the UPS is in ECO mode.

- **Parallel**

Setup Item	Options	Default
Redundant UPS	0 ~ 3 (1 per step)	0
ID	1 ~ 4 (1 per step)	1
Common Battery	Yes/ No	No

- **On/ Off Settings**

Setup Item	Options	Default
Energy Saving	Option 1: Enable/ Disable Option 2: 1 min ~ 15 mins (1 min per step) Option 3: 600W ~ 3000W (100W per step)	Disable
Sleep Mode	Option 1: Enable/ Disable Option 2: 10 mins ~ 120 mins (10 mins per step)	Disable
Auto Restart	Enable/ Disable	Enable
Auto Start on AC	Enable/ Disable	Disable

- Battery

Setup Item	Options	Default
Automatic Battery Test	No Test/ Daily/ Weekly/ Bi-weekly/ Monthly	No Test
Deep Discharge Test	20% ~ 90% (10% per step)	90%
Low Battery Warning Capacity	0% ~ 95% (5% per step)	10%
Warning of Remaining Time	0 min ~ 60 mins (1 min per step)	2 mins
Runtime Limitation	Disable/ 1/ 2/ 3 .../ 240 mins (1 min per step)	Disable
Charge Mode	2-stage/ 3-stage	2-stage
Internal Charging Current	1.5/ 2/ 3/ 4/ 5/ 6/ 7/ 8A	1.5A
External Battery Source	Standard Battery Pack/ Customer Own Batt. Pack	Standard Battery Pack
External Battery Type	Standard Battery Pack: Lead-Acid Battery Lithium-ion Battery Customer Own Batt. Pack: Lead-Acid Battery Others	Lead-Acid Battery
(Standard Battery Pack - Lead-Acid Battery) Model Name Quantity Float Charging Voltage EOD Voltage	Model Name: RT-10KB Quantity: 1 ~ 999 Float Charging Voltage: Auto (2.27 Vdc/ cell) 2.23 Vdc/cell ~ 2.3 Vdc/ cell (0.01 Vdc/ cell per step) EOD Voltage: 10.5 Vdc/ PC	Model Name: RT-10KB Float Charging Voltage: Auto

Setup Item	Options	Default
(Standard Battery Pack – Lithium-ion Battery) Rated Voltage Total Capacity Float Charging Voltage EOD Voltage	(displays automatically, no settable items)	N/A
(Customer Own Batt. Pack - Lead-Acid Battery) Voltage/Qty Total Capacity Float Charging Voltage EOD Voltage	Voltage/Qty: 144 Vdc/12 PCS, 192 Vdc/16 PCS, 204 Vdc/17 PCS, 216 Vdc/18 PCS, 228 Vdc/19 PCS, 240 Vdc/20 PCS, 252 Vdc/21 PCS, 264 Vdc/22 PCS Total Capacity: 1 ~ 999 (Ah) Float Charging Voltage: Auto (2.27 Vdc/cell) 2.23 Vdc/cell ~ 2.3 Vdc/cell (0.01 Vdc/cell per step) EOD Voltage: 10.5 Vdc/PC ~ 11 Vdc/PC (0.1 Vdc/PC per step)	Voltage/Qty: 240 Vdc/20 PCS Float Charging Voltage: Auto EOD Voltage: 10.5 Vdc/PC
(Customer Own Batt. Pack - Others) Rated Voltage Float Charging Voltage EOD Voltage	Rated Voltage: 144 Vdc ~ 264 Vdc (1Vdc per step) Float Charging Voltage: 150 Vdc ~ 310 Vdc (1V per step) EOD Voltage: 114 Vdc ~ 242 Vdc (1V per step)	Rated Voltage: 240 Vdc Float Charging Voltage: 272 Vdc EOD Voltage: 210 Vdc
Install date	YYYY/ MM/ DD	

**NOTE:**

When setting 'Quantity' for Standard Battery Pack – Lead-acid Battery, a pair of Delta lead-acid battery packs are considered '1'.

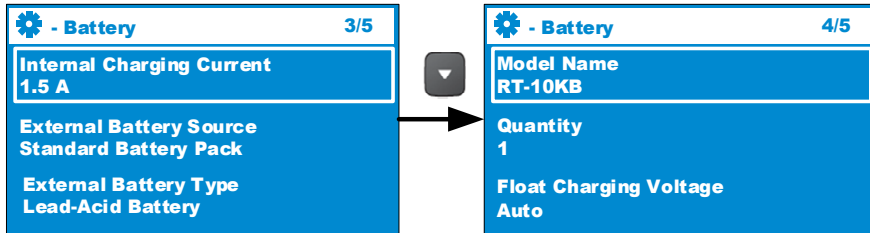

- **General**

Setup Item	Options	Default
Language	English/ 简体中文/ 繁體中文	English
Audible Alarm	Enable/ Disable	Enable
LCD Back Light	Always On/ Auto Off	Auto Off
Date	YYYY/ MM/ DD	
Time	HH:MM:SS	

- **Dry Contact Setting**

Setup Item	Options	Default
Dry Contact 1 - Input	Option 1*1: Disable/ ROO/ RPO/ Remote Shutdown/ Forced Bypass/ On Generator Option 2: 0s ~ 999s (1s per step) Option 3: Normally Open/ Normally Closed	Disable
Dry Contact 2 - Output	Disable/ On Battery/ Low Battery/ Battery Fault/ Bypass/ UPS OK/ Load Protected/ Load Powered/ General Alarm/ Overload Alarm	On Batt.

Setup Item	Options	Default
Dry Contact 3 - Output	Disable/ On Battery/ Low Battery/ Battery Fault/ Bypass/ UPS OK/ Load Protected/ Load Powered/ General Alarm/ Overload Alarm	Low Batt.
Dry Contact 4 - Output	Disable/ On Battery/ Low Battery/ Battery Fault/ Bypass/ UPS OK/ Load Protected/ Load Powered/ General Alarm/ Overload Alarm	General Alarm
Remote Control	Option 1: REPO/ ROO Option 2: (For REPO) Normally Open/ Normally Closed; or (For ROO) Delay Time 0s ~ 999s (1s per step)	REPO/ NO



NOTE:

1. *1 For detailed information about option 1, please contact service personnel.

● **Component Life Prediction**

Options	Default
Fan Life Prediction	Yes/ No

10.2.3 Control Menu

In the **Main Menu**, select **Control** () to enter the **Control Menu**.

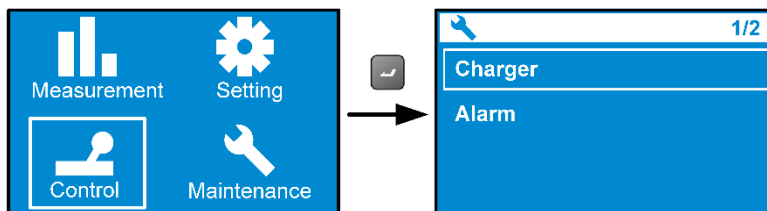

You can enable specific UPS functions through the **Control Menu**. Please refer to the table below for more information.

Level 1	Level 2	Level 3	Level 4
Control	Charger	Execute Boost Charge	No/ Yes
	Alarm	Clear Prediction Warning	No/ Yes* ¹



NOTE:

*¹ The item **Delay Alarm Again** can be set from 1 week to 52 weeks; you can access from → **Alarm** → **Clear Prediction Warning** → **Yes**. You need to go to **Setting Menu** → **Component Life Prediction** → select **Yes**. You can perform 'Clear Prediction Warning' when the alarm is triggered only after the setting has been done.

If you need to charge the batteries in boost mode, please go to → **Charger** → **Execute Boost Charge** → **Yes**.

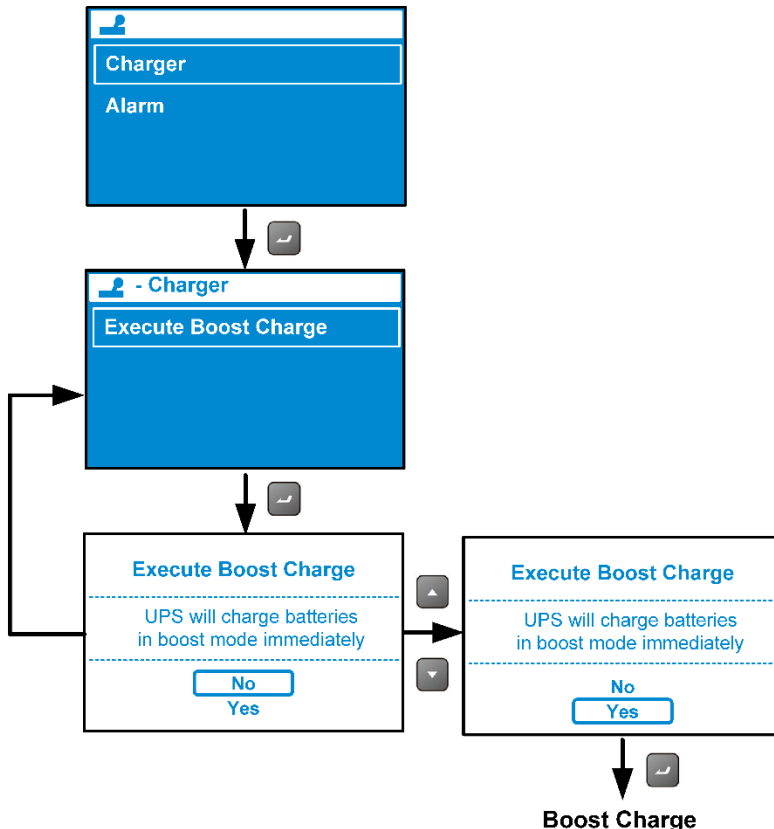

10.2.4 Maintenance Menu

In **Main Menu**, select **Maintenance** () to enter the **Maintenance Menu**.

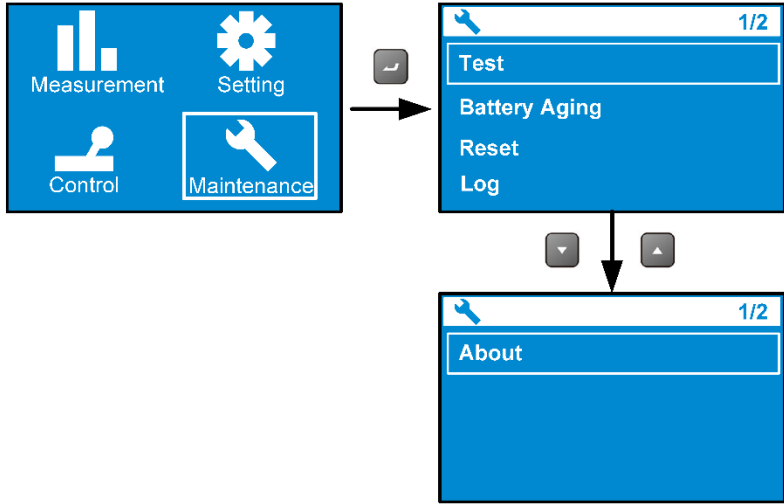

You can identify the UPS, view the event log, and enable the maintenance functions through the **Maintenance Menu**. For more information, please refer to the table below.

Level 1	Level 2	Level 3	Level 4	Level 5
Maintenance	Test	Start Battery Test	In Progress...	Test Result: Pass
				Test Result: FAIL
				Test Result: Not Finished
		Deep Discharge Test	In Progress...	Test Result: Pass
				Test Result: FAIL
				Test Result: Not Finished
	Local Output Dry Contact Test	Dry Contact 2	Dry Contact 2 In Progress...	
		Dry Contact 3	Dry Contact 3 In Progress...	
		Dry Contact 4	Dry Contact 4 In Progress...	

Level 1	Level 2	Level 3	Level 4	Level 5
Maintenance	Battery Aging	Create Discharging Reference	Yes/ Cancel	
		Discharging History	Item, Watts, T-total	Date/ Time, Average Watts, Actual Discharging Time, Est. Remaining Time, Total Discharging Time
	Reset	Reset Power Usage Data	Yes/ Cancel	
		Restore Factory Setting	Yes/ Cancel	
	Log	Event List	Date/ Time, Event Code, Alarm Message	
		Clear Log	Yes/ Cancel	
	About	Model Name: RT-20K3P		
		UPS - Part No. UPS203R6RT2N035		
		UPS - Serial No. ACF0123456789		
		UPS - Manufacture Date YYYY - MM		
		UPS - Firmware Version 0H0030AR00.04.00 0H0030AR00.03.00 0H0030AR00.05.00		

Level 1	Level 2	Level 3	Level 4	Level 5
Maintenance	About	Battery Summary: Installed YYYY/ MM/ DD Replace YYYY/ MM/ DD		

For example, if you need to execute a battery test, please go to  → **Test** → **Start Battery**
Test → **In Progress...** → **Test Result: Pass (or FAIL).**

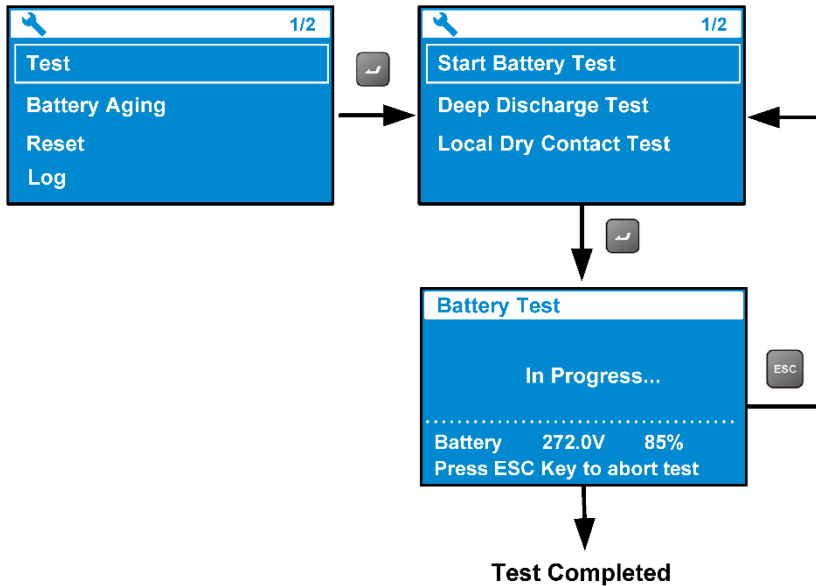

Once the test is completed, the test result will be shown as follows.

A. Test Result: FAIL

The alarm icon will show at the left bottom of the LCD display.

B. Tests Result: Pass

No alarm icon appears, and the UPS runs normally.

A.

Battery Test

Test Result: FAIL

Battery 272.0V 0%

Press ESC key to Escape



ONLINE

75%

 0x1012 01

Alarm Icon

B.

Battery Test

Test Result: Pass

Battery 272.0V 80%

Press ESC key to Escape



ONLINE

100 %

75%

Input 232.0 V 50.0 Hz

Ouput 232.0 V 50.0 Hz

Chapter 11 : Optional Accessories

There are several optional accessories available for the RT series UPS. Please refer to the table below for the optional accessories and their functions.

No.	Item	Functions
1	Dust Filter	Prevents dust from entering into the UPS to ensure UPS reliability and to prolong product lifespan.
2	Mini SNMP IPv6 Card	Monitors and controls the status of the UPS via a network system.
3	Mini Relay I/O Card	Increase the number of dry contacts.
4	Mini MODBUS Card	Lets the UPS have MODBUS communication function.
5	Delta Lead-acid Battery Pack	Provides lead-acid batteries to the UPS so that the unit can continue supplying power to its connected loads when a power outage occurs.
6	Delta Lithium-ion Battery Pack (RT-20K-LIB/ RT-10K-LIB)	Provides lithium-ion batteries to the UPS so that the unit can continue supplying power to its connected loads when a power outage occurs.
7	Maintenance Bypass Box (MBB) for single UPS	Lets the UPS continue supplying power (single-phase output or three-phase output) to its connected loads when the UPS is under maintenance.
8	Power Distribution Box (PDB) for single UPS/ parallel UPSs	A 3U power distribution box, which can be connected to the single UPS or two parallel UPSs to provide (1) single-phase/ three-phase output and (2) manual bypass function for maintenance. The PDB also provides four IEC-320 C13 outlets and two IEC-320 C19 outlets to meet your power distribution needs.
9	Rack Remote Power Panel (rRPP)	A 3U power distribution box, which can be connected to the UPS or PDB. The rRPP (1) provides single-phase/ three-phase output, (2) can monitor the voltage and current provided to the loads, and (3) have communication function.
10	Rail Kit	Fixes the UPS in a rack cabinet.



NOTE:

1. For detailed installation and operation information of any accessory mentioned above, please refer to the **Quick Guide**, **User Guide**, or **Installation & Operation Guide** included in their package.
2. If you want to buy any accessory mentioned above, please contact your local dealer or customer service.

Chapter 12 : Troubleshooting

1. When a problem occurs, please check if the following situation exists before contacting Delta service personnel.

- Is the main input voltage present?

2. Please have the following information ready before contacting the Delta service personnel.

- Unit information including model, serial number, etc.
- An exact description of the problem; the more detailed, the better.

3. When you see the following problems occur, please refer to the solutions shown below.



NOTE:

If all possible causes below are eliminated but the alarm still appears, please contact your local dealer or customer service.

Event Code	Alarm Message	Possible Cause	Solution
0x0288	Bypass STS/ Relay Abnormal	The bypass SCR or relay is broken.	Please contact service personnel.
0x1002	Battery Over Charged	The charger voltage is too high.	Please contact service personnel.
0x1003	Battery Disconnected	1. The UPS is not properly connected to the external battery pack(s). 2. The battery/ batteries is (are) damaged.	Check whether the UPS is properly connected to the external battery pack(s).
0x1101	Output Overload Shutdown	The UPS is overloaded.	Check the power consumption of the loads, and remove the unnecessary loads.

Event Code	Alarm Message	Possible Cause	Solution
0x1200	INV Volt Abnormal	The UPS has an internal fault.	Please contact service personnel.
0x2300	System Fan Abnormal - 1	The fan is locked or broken.	1. Check whether the fan is locked. 2. Please contact service personnel.
0x2301	System Fan Abnormal - 2	The fan is locked or broken.	1. Check whether the fan is locked. 2. Please contact service personnel.
0x2302	System Fan Abnormal - 3	The fan is locked or broken.	1. Check whether the fan is locked. 2. Please contact service personnel.
0x2504	EXT Parallel Comm Loss	The communication between the parallel units is lost.	Check the communication cables between the parallel units.
0x2506	Parallel Unit Incompatible	The firmware version of the parallel units is not the same.	1. Check the firmware version of the parallel units. 2. Upgrade the firmware.
0x250C	Main Input Backfeed Fault	The bypass SCR or relay is short-circuited.	Please contact service personnel.
0x2515	System Ambient Over Temperature Shutdown	The ambient temperature is too high.	Check whether the ambient temperature is too high.
0x2516	System Fan Pwr Fault	The voltage of the fan is abnormal.	Please contact service personnel.

Event Code	Alarm Message	Possible Cause	Solution
0x2530	Parallel I/O Abnormal	The communication between the parallel units is abnormal.	1. Check the communication cables between the parallel units. 2. Please contact service personnel.
0x2538	INV PLL Ref Bus Abnormal	The communication between the parallel units is abnormal.	1. Check the communication cables between parallel units. 2. Please contact service personnel.
0x253B	Parallel Unit Config Incompatible - AC In Type	The parameters of the parallel units are not the same.	Check the parameters of the parallel units.
0x253C	Parallel Unit Config Incompatible - Bat Type	The parameters of the parallel units are not the same.	Check the parameters of the parallel units.
0x253D	Parallel Unit Config Incompatible - Output Type	The parameters of the parallel units are not the same.	Check the parameters of the parallel units.
0x253F	Parallel Unit Config Conflict	The parameters of the parallel units are not the same.	Check the parameters of the parallel units.
0x4740	Ext Parallel Unit Abnormal Absent	The parallel units are abnormal.	1. Check all the parallel units. 2. Please contact service personnel.
0x6081	Local Comm Loss	The internal communication is lost.	Please contact service personnel.
0x6083	MONCAN Comm Loss	The internal communication is lost.	Please contact service personnel.

Event Code	Alarm Message	Possible Cause	Solution
0x60C0	PFC Soft Start Fail	The UPS has an internal fault.	Please contact service personnel.
0x61C1	Mains Input Fuse Open	The input fuses have melted.	Please contact service personnel.
0x612C	Rectifier Over Heat Shutdown	1. The vents are blocked. 2. The UPS has an internal fault.	1. Check whether the vents are blocked. 2. Contact service personnel.
0x6201 0x8221	DC Bus Over Shutdown	1. The output is connected to capacitive loads or inductive loads. 2. The UPS has an internal fault.	1. Remove capacitive loads or inductive loads. 2. Please contact service personnel.
0x6281 0x82C1	DC Bus Under Shutdown	The UPS has an internal fault.	Please contact service personnel.
0x6380	PFC Supervisor Fault	The UPS has an internal fault.	Please contact service personnel.
0x8081	Local Comm Loss	The internal communication is lost.	Please contact service personnel.
0x8082	INTCAN Comm Loss	The internal communication is lost.	Please contact service personnel.
0x8083	MONCAN Comm Loss	The internal communication is lost.	Please contact service personnel.
0x80C0	INV Soft Start Fail	The UPS has an internal fault.	Please contact service personnel.
0x8107	Over Heat Shutdown - R	1. The vents are blocked. 2. The UPS has an internal fault.	1. Check whether the vents are blocked. 2. Contact service personnel.
0x8108	Over Heat Shutdown - S	1. The vents are blocked. 2. The UPS has an internal fault.	1. Check whether the vents are blocked. 2. Contact service personnel.

Event Code	Alarm Message	Possible Cause	Solution
0x8109	Over Heat Shutdown - T	1. The vents are blocked. 2. The UPS has an internal fault.	1. Check whether the vents are blocked. 2. Contact service personnel.
0x8380	INV Supervisor Fault	The UPS has an internal fault.	Please contact service personnel.
0x83C3	Output Relay Fault - R	The INV output relay is broken.	Please contact service personnel.
0x83C4	Output Relay Fault - S	The INV output relay is broken.	Please contact service personnel.
0x83C5	Output Relay Fault - T	The INV output relay is broken.	Please contact service personnel.
0x8581*1	INV Over Current Shutdown - R	The UPS output phase L1 is short-circuited.	Check whether the output is short-circuited.
0x8582*1	INV Over Current Shutdown - S	The UPS output phase L2 is short-circuited.	Check whether the output is short-circuited.
0x8583*1	INV Over Current Shutdown - T	The UPS output phase L3 is short-circuited.	Check whether the output is short-circuited.
0x8640	INV DC Offset Fault Shutdown	The INV output DC offset is abnormal.	Please contact service personnel.
0xA001	Charger Fault	The UPS has an internal fault.	Please contact service personnel.
0xA002	Charger Fault	The UPS has an internal fault.	Please contact service personnel.
0xA080	Battery Fuse Open	The battery fuses have melted.	Please contact service personnel.

Event Code	Alarm Message	Possible Cause	Solution
0xA081	Charger Fuse Open	The charger fuses have melted.	Please contact service personnel.
0xA082	Charger Output Switch Abnormal	The charger output switch is broken.	Please contact service personnel.
0xA101	Charger Over Heat Shutdown	1. The vents are blocked. 2. The UPS has an internal fault.	1. Check whether the vents are blocked. 2. Contact service personnel.
0x8585*2	INV Overcurrent Warning - R	Overcurrent occurs in UPS output phase L1.	Check the power consumption of the loads.
0x8586*2	INV Overcurrent Warning - S	Overcurrent occurs in UPS output phase L2.	Check the power consumption of the loads.
0x8587*2	INV Overcurrent Warning - T	Overcurrent occurs in UPS output phase L3.	Check the power consumption of the loads.



NOTE:

1. *1 The time for the UPS to trigger short circuit protection will be influenced by the internal components' temperature.
2. *2 When the UPS (1) connects to a non-linear load, (2) operates in ECO mode or (3) runs in parallel, an inverter output overcurrent may occur; thus, it is normal if the alarm message shows up for a short period of time. However, if the alarm message continues to exist, please contact service personnel.

Chapter 13 : Maintenance

13.1 UPS

- **UPS Cleaning**

Regularly clean the UPS, especially the slits, openings and filters, to ensure that the air freely flows into the UPS to avoid overheating. If necessary, use an air blower to clean the slits and openings, and clean and replace the filters regularly to prevent any object from blocking or covering these areas.

- **UPS Regular Inspection**

- a. Monthly check the filters, and regularly clean and replace them.
- b. Regularly check the UPS every half year and inspect:
 - 1) Whether the UPS, LED indicators, and alarm function are operating normally.
 - 2) Whether the UPS works in bypass mode (normally, the UPS works in normal mode). If yes, check if any error, overload, internal fault, etc. occurs.
 - 3) Whether the battery voltage is normal. If the battery voltage is too high or too low, find the root cause.

13.2 Batteries

The RT 10/ 15/ 20kVA UPS uses lead-acid, lithium-ion, or other batteries. Make sure to replace the batteries according to the battery lifetime. However, the actual battery lifetime depends on the environment temperature, usage, and charging/ discharging frequency. High environment temperature and high charging/ discharging frequency will quickly shorten the battery lifetime.

Battery inspection and maintenance are required periodically. Please follow the suggestions below to ensure a normal battery lifetime.

- Keep the usage temperature at 20°C ~ 25°C (68°F ~ 77°F).
- Idle lead-acid batteries must be fully recharged (for at least 24 hours) every three months if the UPS needs to be stored for an extended period of time. As for lithium-ion batteries and other batteries, please contact your battery vendor for the information. Regardless of battery type, please fully charge the batteries until the battery percentage shown on the LCD is 100%





NOTE:

1. To charge the batteries, please connect the external battery pack to the UPS.
 2. If the batteries need to be replaced, please contact qualified service personnel.
- During battery replacement, the loads connected to the UPS will not be protected if input power fails.

13.3 Fan

Higher temperatures shorten fan life. When the UPS is running, please check if each fan works normally and make sure if the ventilation air can move freely around and through the UPS. If not, replace the fans immediately.



NOTE:

Please ask your local dealer or customer service for more maintenance information. Do not perform maintenance if you are not trained for it.

Appendix 1 : Technical Specifications

Model		RT-10K3P	RT-15K3P	RT-20K3P
Power Rating		10kVA/10kW	15kVA/15kW	20kVA/20kW
Waveform		Pure Sine Wave		
Input	Nominal Voltage	380/220 Vac, 400/230 Vac, 415/240 Vac (3Φ4W + G)		
	Voltage Range	305 ~ 485 Vac (100% load); 138 ~ 305 Vac (40% ~ 100% load)		
	Frequency	50/60 Hz ± 10 Hz		
	Power Factor	0.99 (full load)		
	iTHD	< 3% (linear load)		
	Connection	Main	Terminal block	
Bypass		Terminal block		
Output	Power Factor	Unity		
	Voltage	380, 400, 415 Vac (3Φ) or 220, 230, 240 Vac (1Φ)		
	Voltage Regulation	± 1% (linear load)		
	Frequency	50/60 Hz ± 0.05 Hz		
	vTHD	< 2% (linear load)		
	Overload Capacity	< 105%: continuous; 105 ~ 125%: 2 minutes; 125% ~ 150%: 30 seconds; > 150%: 200 ms		
	Crest Factor	3:1		
	Connection	Terminal block		
Efficiency	Online Mode	Up to 96.5%		
	ECO Mode	99%		
Battery & Charger	Battery Voltage	144 Vdc, 192 ~ 264 Vdc	± 144 Vdc*1, ± 192 ~ ± 264 Vdc	
	Charging Current	Up to 8A		
Audible Noise		50 dBA	54 dBA	
Display		LED indicators and LCD display		
Communication Interfaces		MINI Slot × 1, Parallel Port × 2, USB Port × 1, REPO/ROO × 1, RS-485 Port × 1, Dry Contact × 4		

Model		RT-10K3P	RT-15K3P	RT-20K3P
Physical	Dimensions (W × D × H)	440 × 649 × 88.2 mm (17.3" × 25.6" × 3.5")	440 × 760 × 88.2 mm (17.3" × 29.9" × 3.5")	
	Weight	16.6 kg (36.6 lb)	22 kg (48.5 lb)	22.5 kg (49.6 lb)
Environment	Operating Altitude	0 m ~ 3000 m (0 ft ~ 9900 ft); 0 m ~ 1000 m (0 ft ~ 3300 ft) without derating		
	Operating Temperature ^{*2}	0°C ~ 55°C (32°F ~ 131°F)		
	Storage Temperature	-15°C ~ 55°C (5°F ~ 131°F)		
	Relative Humidity	5% ~ 95% (non-condensing)		



NOTE:

1. *1 The rated output power of the UPS needs to be de-rated to 70%.
2. *2 When the operating temperature is at 40°C ~ 55°C (104°F ~ 131°F), the rated output power of the UPS needs to be de-rated to 75%. When connected to the Delta lithium-ion battery pack (optional), the UPS operating temperature is 0°C ~ 45°C (32°F ~ 113°F).
3. Please refer to the rating label for the safety certification.
4. All specifications are subject to change without prior notice.
5. When the UPS is connected to the optional Delta Power Distribution Box (PDB), the operating temperature is 0°C~ 40°C (32°F ~ 104°F).
6. Because the optional dust filter will affect the air volume, the rated output power of the UPS needs to be de-rated to 80% at 0°C~ 40°C (32°F ~ 104°F).
7. Because the optional dust filter will affect the air volume, the rated output power of the UPS needs to be de-rated to 60% at 40°C ~ 55°C (104°F ~ 131°F).

Appendix 2 : Warranty

Seller warrants this product, if used in accordance with all applicable instructions, to be free from original defects in material and workmanship within the warranty period. If the product has any failure problem within the warranty period, Seller will repair or replace the product at its sole discretion according to the failure situation.

This warranty does not apply to normal wear or to damage resulting from improper installation, operation, usage, maintenance or irresistible force (i.e. war, fire, natural disaster, etc.), and this warranty also expressly excludes all incidental and consequential damages.

Maintenance service for a fee is provided for any damage out of the warranty period. If any maintenance is required, please directly contact the supplier or Seller.



WARNING:

The individual user should take care to determine prior to use whether the environment and the load characteristic are suitable, adequate or safe for the installation and the usage of this product. The ***User Manual*** must be carefully followed. Seller makes no representation or warranty as to the suitability or fitness of this product for any specific application.

No. : 501329480101

Version : V 1.1

Release Date : 2021_10_27

- Global Headquarter

Taiwan

Delta Electronics Inc.
39 Section 2, Huandong Road, Shanhua District,
Tainan City 74144, Taiwan
T +886 6 505 6565
E ups.taiwan@deltaww.com

- Regional Office

The United States

Delta Electronics (Americas) Ltd.
46101 Fremont Blvd. Fremont, CA 94538
T +1 510 344 2157
E ups.na@deltaww.com

Australia

Delta Energy Systems Australia Pty Ltd.
Unit 20-21, 45 Normanby Road, Notting Hill VIC 3168, Australia
T +61 3 9543 3720
E ups.australia@deltaww.com

South America

Delta Electronics Brasil Ltda.
Estrada Velha Rio São Paulo, 5300 Bairro Eugenio de Melo
12247-001 - São José dos Campos - SP - Brasil
T +55 12 3935-2300
E ups.brazil@deltaww.com

Thailand

Delta Electronics (Thailand) Public Co.,Ltd.
909 Soi 9, Moo 4, E.P.Z., Bangpoo Industrial Estate, Tambon Prakasa,
Amphur Muang-samutprakarn, Samutprakarn Province 10280, Thailand
T +662 709-2800
E ups.thailand@deltaww.com

China

Delta GreenTech (China) Co., Ltd.
238 Minxia Road, Pudong, Shanghai, 201209 P.R.C
T +86 21 5863 5678
+86 21 5863 9595
E ups.china@deltaww.com

South Korea

Delta Electronics (Korea), Inc.
1511, Byucksan Digital Valley 6-cha, Gasan-dong, Geumcheon-gu,
Seoul, Korea, 153-704
T +82-2-515-5303
E ups.south.korea@deltaww.com

Singapore

Delta Electronics Int'l (Singapore) Pte Ltd.
4 Kaki Bukit Ave 1, #05-04, Singapore 417939
T +65 6747 5155
E ups.singapore@deltaww.com

India

Delta Power Solutions (India) Pvt. Ltd.
Plot No. 43, Sector-35, HSIIDC, Gurgaon-122001, Haryana, India
T +91 124 4874 900
E ups.india@deltaww.com

EMEA

Delta Electronics (Netherlands) BV
Zandsteen 15, 2132MZ Hoofddorp, The Netherlands
T +31 20 655 09 00
E ups.netherlands@deltaww.com

Japan

Delta Electronics (Japan), Inc.
2-1-14 Shibadaimon, Minato-Ku, Tokyo, 105-0012, Japan
T +81-3-5733-1111
E jpstps@deltaww.com

UK

Delta Electronics Europe Limited
1 Redwood Court, Peel Park, East Kilbride, G74 5PF,
Scotland, United Kingdom
T +44 1355 588 888
E sales.gb@eltek.com



5013294801